

Pioneer

DVD PLAYER

DVD-V555

Operating Instructions

IMPORTANT



The lightning flash with arrowhead symbol, within an equilateral triangle, is intended to alert the user to the presence of uninsulated "dangerous voltage" within the product's enclosure that may be of sufficient magnitude to constitute a risk of electric shock to persons.

CAUTION

**RISK OF ELECTRIC SHOCK
DO NOT OPEN**

CAUTION:
TO PREVENT THE RISK OF ELECTRIC SHOCK, DO NOT REMOVE COVER (OR BACK). NO USER-SERVICEABLE PARTS INSIDE. REFER SERVICING TO QUALIFIED SERVICE PERSONNEL.



The exclamation point within an equilateral triangle is intended to alert the user to the presence of important operating and maintenance (servicing) instructions in the literature accompanying the appliance.

IMPORTANT SAFETY INSTRUCTIONS

READ INSTRUCTIONS — All the safety and operating instructions should be read before the product is operated.

RETAIN INSTRUCTIONS — The safety and operating instructions should be retained for future reference.

HEED WARNINGS — All warnings on the product and in the operating instructions should be adhered to.

FOLLOW INSTRUCTIONS — All operating and use instructions should be followed.

CLEANING — Unplug this product from the wall outlet before cleaning. The product should be cleaned only with a polishing cloth or a soft dry cloth. Never clean with furniture wax, benzene, insecticides or other volatile liquids since they may corrode the cabinet.

ATTACHMENTS — Do not use attachments not recommended by the product manufacturer as they may cause hazards.

WATER AND MOISTURE — Do not use this product near water — for example, near a bathtub, wash bowl, kitchen sink, or laundry tub; in a wet basement; or near a swimming pool; and the like.

ACCESSORIES — Do not place this product on an unstable cart, stand, tripod, bracket, or table. The product may fall, causing serious injury to a child or adult, and serious damage to the product. Use only with a cart, stand, tripod, bracket, or table recommended by the manufacturer, or sold with the product. Any mounting of the product should follow the manufacturer's instructions, and should use a mounting accessory recommended by the manufacturer.

CART — A product and cart combination should be moved with care. Quick stops, excessive force, and uneven surfaces may cause the product and cart combination to overturn.



VENTILATION — Slots and openings in the cabinet are provided for ventilation and to ensure reliable operation of the product and to protect it from overheating, and these openings must not be blocked or covered. The openings should never be blocked or covered by placing the product on a bed, sofa, rug, or other similar surface. This product should not be placed in a built-in installation such as a bookcase or rack unless proper ventilation is provided or the manufacturer's instructions have been adhered to.

POWER SOURCES — This product should be operated only from the type of power source indicated on the marking label. If you are not sure of the type of power supply to your home, consult your product dealer or local power company.

LOCATION — The appliance should be installed in a stable location.

NONUSE PERIODS — The power cord of the appliance should be unplugged from the outlet when left unused for a long period of time.

GROUNDING OR POLARIZATION

If this product is equipped with a polarized alternating current line plug (a plug having one blade wider than the other), it will fit into the outlet only one way. This is a safety feature. If you are unable to insert the plug fully into the outlet, try reversing the plug. If the plug should still fail to fit, contact your electrician to replace your obsolete outlet. Do not defeat the safety purpose of the polarized plug.

If this product is equipped with a three-wire grounding type plug, a plug having a third (grounding) pin, it will only fit into a grounding type power outlet. This is a safety feature. If you are unable to insert the plug into the outlet, contact your electrician to replace your obsolete outlet. Do not defeat the safety purpose of the grounding type plug.

POWER-CORD PROTECTION — Power-supply cords should be routed so that they are not likely to be walked on or pinched by items placed upon or against them, paying particular attention to cords at plugs, convenience receptacles, and the point where they exit from the product.

OUTDOOR ANTENNA GROUNDING — If an outside antenna or cable system is connected to the product, be sure the antenna or cable system is grounded so as to provide some protection against voltage surges and built-up static charges. Article 810 of the National Electrical Code, ANSI/NFPA 70, provides information with regard to proper grounding of the mast and supporting structure, grounding of the lead-in wire to an antenna discharge unit, size of grounding conductors, location of antenna-discharge unit, connection to grounding electrodes, and requirements for the grounding electrode. See Figure A.

LIGHTNING — For added protection for this product during a lightning storm, or when it is left unattended and unused for long periods of time, unplug it from the wall outlet and disconnect the antenna or cable system. This will prevent damage to the product due to lightning and power-line surges.

POWER LINES — An outside antenna system should not be located in the vicinity of overhead power lines or other electric light or power circuits, or where it can fall into such power lines or circuits. When installing an outside antenna system, extreme care should be taken to keep from touching such power lines or circuits as contact with them might be fatal.

OVERLOADING — Do not overload wall outlets, extension cords, or integral convenience receptacles as this can result in a risk of fire or electric shock.

OBJECT AND LIQUID ENTRY — Never push objects of any kind into this product through openings as they may touch dangerous voltage points or short-out parts that could result in a fire or electric shock. Never spill liquid of any kind on the product.

SERVICING — Do not attempt to service this product yourself as opening or removing covers may expose you to dangerous voltage or other hazards. Refer all servicing to qualified service personnel.

DAMAGE REQUIRING SERVICE — Unplug this product from the wall outlet and refer servicing to qualified service personnel under the following conditions: When the power-supply cord or plug is damaged. If liquid has been spilled, or objects have fallen into the product.

If the product has been exposed to rain or water. If the product does not operate normally by following the operating instructions. Adjust only those controls that are covered by the operating instructions as an improper adjustment of other controls may result in damage and will often require extensive work by a qualified technician to restore the product to its normal operation.

If the product has been dropped or damaged in any way. When the product exhibits a distinct change in performance — this indicates a need for service.

REPLACEMENT PARTS — When replacement parts are required, be sure the service technician has used replacement parts specified by the manufacturer or have the same characteristics as the original part. Unauthorized substitutions may result in fire, electric shock, or other hazards.

SAFETY CHECK — Upon completion of any service or repairs to this product, ask the service technician to perform safety checks to determine that the product is in proper operating condition.

WALL OR CEILING MOUNTING — The product should not be mounted to a wall or ceiling.

HEAT — The product should be situated away from heat sources such as radiators, heat registers, stoves, or other products (including amplifiers) that produce heat.

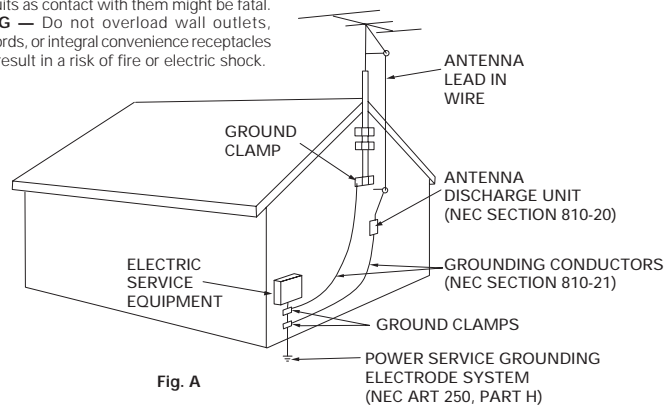

Fig. A

NEC - NATIONAL ELECTRICAL CODE

Thank you for buying this Pioneer product.
Please read through these operating instructions so you will know how to operate your model properly. After you have finished reading the instructions, put them away in a safe place for future reference.

- This player is not suitable for commercial use.

WARNING: TO PREVENT FIRE OR SHOCK HAZARD, DO NOT EXPOSE THIS APPLIANCE TO RAIN OR MOISTURE.

IMPORTANT NOTICE

The serial number for this equipment is located on the rear panel. Please write this serial number on your enclosed warranty card and keep it in a secure area. This is for your security.

CAUTION: This product satisfies FCC regulations when shielded cables and connectors are used to connect the unit to other equipment. To prevent electromagnetic interference with electric appliances such as radios and televisions, use shielded cables and connectors for connections.

THE POWER SWITCH IS SECONDARY CONNECTED AND THEREFORE DOES NOT SEPARATE THE UNIT FROM MAINS POWER IN STANDBY POSITION.

This equipment has been tested and found to comply with the limits for a Class B digital device, pursuant to Part 15 of the FCC Rules. These limits are designed to provide reasonable protection against harmful interference in a residential installation. This equipment generates, uses, and can radiate radio frequency energy and, if not installed and used in accordance with the instructions, may cause harmful interference to radio communications. However, there is no guarantee that interference will not occur in a particular installation. If this equipment does cause harmful interference to radio or television reception, which can be determined by turning the equipment off and on, the user is encouraged to try to correct the interference by one or more of the following measures:

- Reorient or relocate the receiving antenna.
- Increase the separation between the equipment and receiver.
- Connect the equipment into an outlet on a circuit different from that to which the receiver is connected.
- Consult the dealer or an experienced radio/TV technician for help.

Information to User

Alteration or modifications carried out without appropriate authorization may invalidate the user's right to operate the equipment.

CAUTION

- Use of controls or adjustments or performance of procedures other than those specified herein may result in hazardous radiation exposure.
- The use of optical instruments with this product will increase eye hazard.

See What You Can Do

Dolby Digital*

Connect to a Digital Surround Amplifier and Surround Processor for 5.1ch Dolby Digital Surround entertainment.



Reserving a Desired Song*

Lets you play back selected titles and chapters in any desired order.

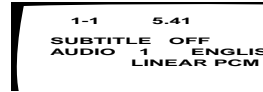

PBC Video CD Compatibility

Ready to play Video CDs (Version 2.0) with PBC (Play Back Control). Two types of playback possible depending on the disc.

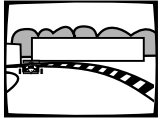

Multi-Aspect*

You can select between Regular, Wide, and Letter Box display formats.



GUI Operation

While viewing Pioneer's original GUI on-screen displays, you can perform operations by remote control. Even if there is no menu recorded on a disc, you can still perform GUI operation with the menu provided by the player.

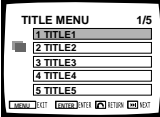

Cinema Mode & Animation Mode*

Lets you select the ideal picture quality for watching movies and animation movies.



Last Memory Play*

If you stop watching a video part way through, this lets you continue watching from the same place later.



Condition Memory*

The following settings of DVDs that you often watch can be recorded, and recalled automatically.

- Multi Aspect
- Cinema Mode/Animation Mode
- Multi-Language Subtitles
- Multi-Language
- Position

Still Frame*

You can view still frames.



Multilingual Subtitles*

You can select a desired subtitle language when watching movies and other videos.

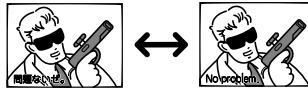

Repeat Play*

Wide range of Repeat Play possibilities.

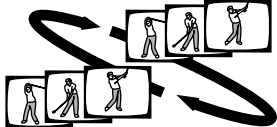

Multi-Angle*

Lets you view scenes from different camera angles.

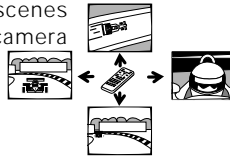

Parental Level*

Lets you select a "parental level" (user restriction level) to prevent children viewing undesirable material.

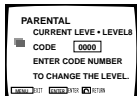

Multiple Languages*

With discs that have multiple language soundtracks recorded on them, you can select the desired language.

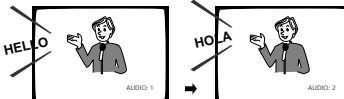

This product incorporates copyright protection technology that is protected by method claims of certain U. S. patents and other intellectual property rights owned by Macrovision Corporation and other rights owners. Use of this copyright protection technology must be authorized by Macrovision Corporation, and is intended for home and other limited viewing uses only unless otherwise authorized by Macrovision Corporation. Reverse engineering or disassembly is prohibited.

* Indicates this feature may not be possible with certain discs.

Disc Types Compatible with This Unit

This player is DVD, CD, Video CD, and CD-G compatible. The marks shown on the right are found on disc labels or on disc jackets.



- This player can play all discs bearing the marks on the right without the need for an adaptor.
- To prevent malfunction, do not use an 8 cm (3 in.) adaptor (for CDs).

This unit is compatible with the NTSC TV system (U.S. and Canadian TV system).

You cannot use discs other than those shown on the right.





* During DVD playback, data transfer is at 4.7 MBit per second.

Handling the discs

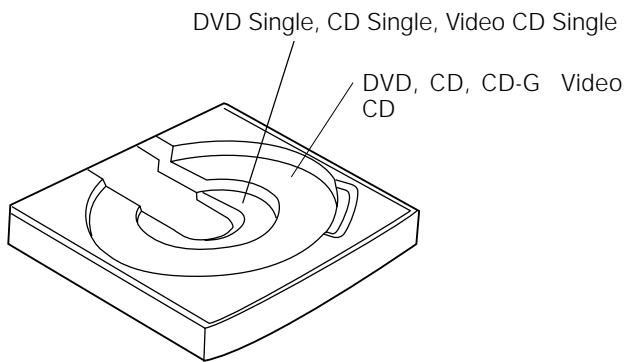
Holding with both hands	
Holding with one hand	

Disc Table



Types of playable discs and their marks	Diameter/Playable sides	Playback time	
DVD VIDEO 	DVD VIDEO*	Digital audio Digital video (MPEG 2)	
	12 cm (5in.)/single-sided	1 layer 2 layer	133 min. (4.7 GB) 242 min. (8.5 GB)
	12 cm (5in.)/double-sided	1 layer 2 layer	266 min. (9.4 GB) 484 min. (17GB)
	DVD VIDEO*		Digital audio Digital video (MPEG 2)
	8 cm (3 in.)/single-sided	1 layer 2 layer	41 min. 75 min.
	8 cm (3 in.)/double-sided	1 layer 2 layer	82 min. 150 min.
VIDEO CD 	VIDEO CD 12 cm (5 in.)/single-sided	Digital audio Digital video (MPEG 1) Max. 74 minutes	
	VIDEO CD single 8 cm (3 in.)/single-sided	Digital audio Digital video (MPEG 1) Max. 20 minutes	
CD  	CD 12 cm (5 in.)/single-sided	Digital audio Max. 74 minutes	
	CD single 8 cm (3 in.)/single-sided	Digital audio Max. 20 minutes	

Discs other than the ones indicated above can not be played on this unit.

To avoid damage etc., do not play any discs other than those indicated above.

Ex: DVD-Audio, DVD-ROM, CD-ROM, CD with special shape etc...

Note

- ◆ You cannot play DVDs that do not bear the Region No. (refer to "Terms" on page 69) indicated on the player's rear panel.

Contents

Applicable discs



			DVD	CD	VIDEO CD	
Basic Operation	Playing DVDs, CDs and Video CDs with No PBC	10	●	●	●	Basic Operation
	Playing Video CDs (with PBC)	11			●	
	Chapter (Track) Skip Forward/Skip Back	13	●	●	●	
	Stopping Playback & Switching Power OFF	14	●	●	●	
	Continuing Playback from Where You Stopped	15	●		●	
Detailed Operation	Playback by Menu Selection	18	●		●	Detailed Operation
	Playing Back CD Graphics	19		●		
	Searching for a Desired Video Scene/Audio Track	20	●	●	●	
	Repeat Play	22	●	●	●	
	Still Frame	23	●		●	
Karaoke Operation	Karaoke Entertainment	26	●	●	●	Karaoke Operation
	Adjusting to Create the Desired Sound	29	●	●	●	
	Echo adjustment	29	●	●		
	Changing performance key	29	●	●		
	Operation is possible with the mic	29	●	●	●	
	Convenient Function for Practicing Karaoke	30	●	●	●	
	Reserving a Desired Song	32	●	●	●	
Sing With Professional Karaoke (GUIDE MELODY)	33	●	●	●		
Setting	Multi-Aspect Setting for Wide Screen TV Software	36	●			Setting
	Changing Picture, Sound Quality and Graphics Setting	38	●	●	●	
	Memorizing Settings for Often Viewed DVDs (Condition Memory)	42	●			
	Selecting Languages (Multi-Language)	43	●			
	Changing Audio Type	43		●	●	
	Selecting a Subtitle Language (Multi-Language Subtitles)	44	●			
	Viewing from a Desired Camera Angle (Multi-Angle)	44	●			
	Viewing Disc Information	45	●	●	●	
	Outline of GUI (Graphical User Interface) Operation	46	●	●	●	
	Changing Settings	52	●	●	●	
How to Set Basic Audio and Subtitles	55	●				
Set-Up	Connecting the Player					Set-Up
	Connection example 1. To a TV with video input	58				
	Connection example 2. AV receiver with digital input for Dolby Digital (AC-3)	59				
	Connection example 3. AV amplifier	60				
	Names and Functions					
	Remote Control	61				
	Front Panel	62				
Rear Panel	62					
Display Window	63					
Other Information	Troubleshooting	64				Other Information
	For Proper and Long Use	66				
	Terms	68				
	Specifications	69				

* will not operate with some modes of disc.

Contents

Applicable discs



			DVD	CD	VIDEO CD	
Basic Operation	Playing DVDs, CDs and Video CDs with No PBC	10	●	●	●	Basic Operation
	Playing Video CDs (with PBC)	11			●	
	Chapter (Track) Skip Forward/Skip Back	13	●	●	●	
	Stopping Playback & Switching Power OFF	14	●	●	●	
	Continuing Playback from Where You Stopped	15	●		●	
Detailed Operation	Playback by Menu Selection	18	●		●	Detailed Operation
	Playing Back CD Graphics	19		●		
	Searching for a Desired Video Scene/Audio Track	20	●	●	●	
	Repeat Play	22	●	●	●	
	Still Frame	23	●		●	
Karaoke Operation	Karaoke Entertainment	26	●	●	●	Karaoke Operation
	Adjusting to Create the Desired Sound	29	●	●	●	
	Echo adjustment	29	●	●		
	Changing performance key	29	●	●		
	Operation is possible with the mic	29	●	●	●	
	Convenient Function for Practicing Karaoke	30	●	●	●	
	Reserving a Desired Song	32	●	●	●	
Sing With Professional Karaoke (GUIDE MELODY)	33	●	●	●		
Setting	Multi-Aspect Setting for Wide Screen TV Software	36	●			Setting
	Changing Picture, Sound Quality and Graphics Setting	38	●	●	●	
	Memorizing Settings for Often Viewed DVDs (Condition Memory)	42	●			
	Selecting Languages (Multi-Language)	43	●			
	Changing Audio Type	43		●	●	
	Selecting a Subtitle Language (Multi-Language Subtitles)	44	●			
	Viewing from a Desired Camera Angle (Multi-Angle)	44	●			
	Viewing Disc Information	45	●	●	●	
	Outline of GUI (Graphical User Interface) Operation	46	●	●	●	
	Changing Settings	52	●	●	●	
How to Set Basic Audio and Subtitles	55	●				
Set-Up	Connecting the Player					Set-Up
	Connection example 1. To a TV with video input	58				
	Connection example 2. AV receiver with digital input for Dolby Digital (AC-3)	59				
	Connection example 3. AV amplifier	60				
	Names and Functions					
	Remote Control	61				
	Front Panel	62				
Rear Panel	62					
Display Window	63					
Other Information	Troubleshooting	64				Other Information
	For Proper and Long Use	66				
	Terms	68				
	Specifications	69				

* will not operate with some modes of disc.

Before Using

Check accessories

Remote control unit

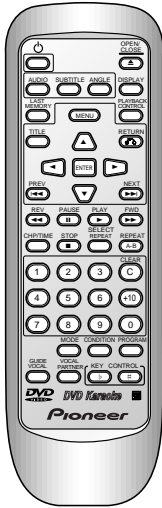

Audio cord

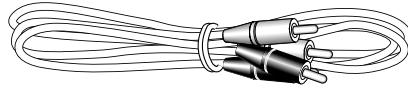

Video cord

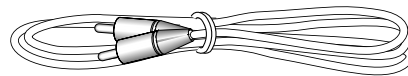

AA/R6P dry cell batteries....2

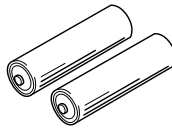

Microphone

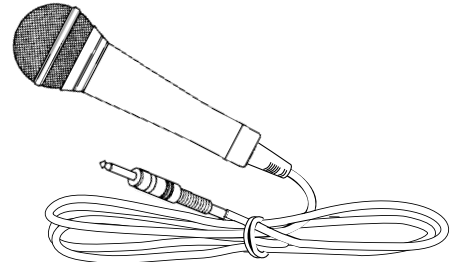

Power cord

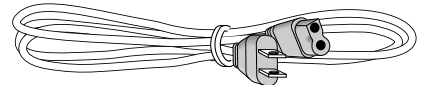

- Other included items:
- Operating Instructions (this manual)
 - Warranty card

Inserting batteries into the remote control

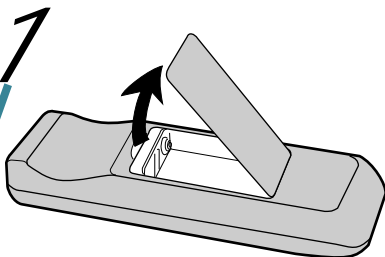

While pressing the back cover, pull out in the direction indicated by the arrow.

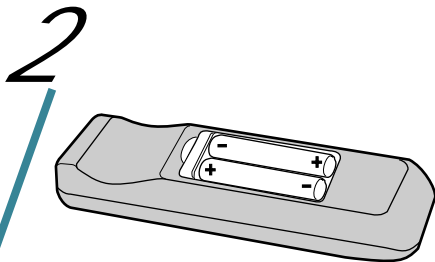

Insert batteries.

Make sure to match the plus (+) and minus (-) polarity guides on the batteries with the marks inside the battery compartment.

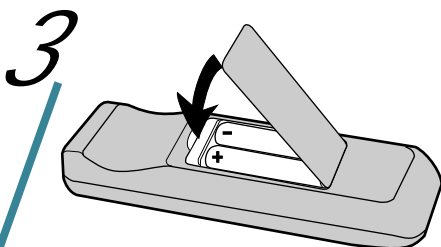

Close the cover.

Note

- ◆ Do not mix old and new batteries.
- ◆ Even batteries of the same type will differ in voltage. Do not mix old batteries with new batteries.
- ◆ When not using the remote control for a long period of time (over 1 month), remove the batteries to avoid possible damage from battery corrosion. If battery leakage occurs, wipe the battery liquid from the battery component, then insert new batteries.

Basic Operation

Playing DVDs, CDs and Video CDs with No PBC	10
Playing Video CDs (with PBC)	11
Chapter (Track) Skip Forward/Skip Back	13
Stopping Playback & Switching Power OFF	14
Continuing Playback from Where You Stopped	15



Playing DVDs, CDs and Video CDs with No PBC

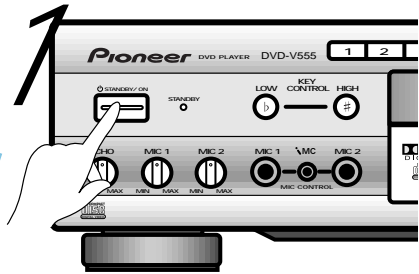

Press the STANDBY/ON button.

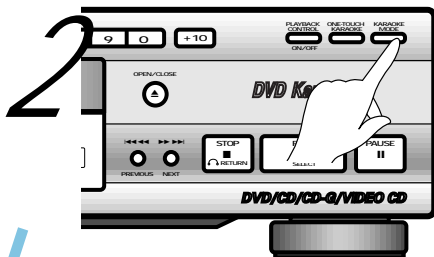

When playing a Video/Audio disc, press the KARAOKE MODE button to select "NORMAL MODE".

Each time you press the button, the setting changes as follows.

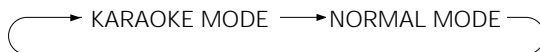

Note

- ◆ DVDs that do not have the matching region No. that allows playback can not be played back (refer to the "Terms" section on page 69).
- ◆ During operation, the following marks may appear on the TV screen.
 - : Appears when this player has performed a prohibited function.
 - : Appears when the disc has performed a prohibited function.
- ◆ After stopping DVD play, if you start play without specifying a title with a menu or other means, the previous title is played.
- ◆ With the KARAOKE MODE (when the KARAOKE MODE button on the front panel is lit), depending on the TV you're using and mic volume level, there may be distortion when playing DVDs, CDs or Video CDs. To prevent this keep analog output sound volume level low.



Press the button.

- Press OPEN/CLOSE button on the remote control unit.
- The disc table comes out.

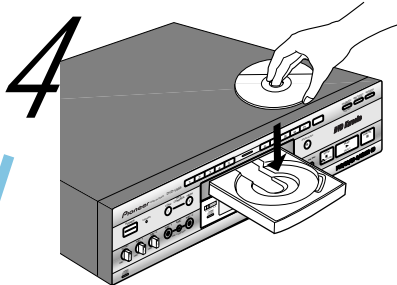

Load a disc.

- Load a disc with the label facing up, using the disc table guide to align the disc.

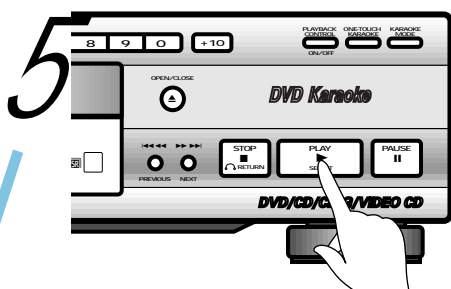

Press the button.

- The disc table will close, and playback will begin.
- Depending on the disc, a menu is displayed. If a menu is displayed, refer to page 18.

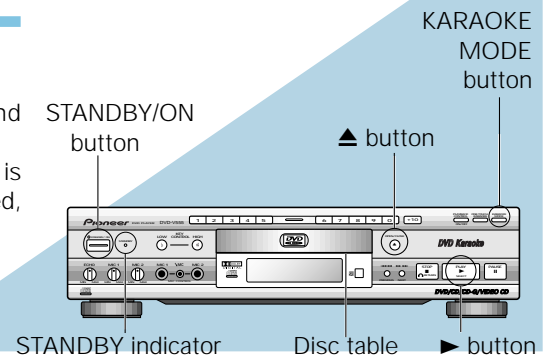

Playing Video CDs (with PBC)

To playback (Video CDs with PBC)

1 Perform steps 1 through 4 on page 10.

2 Press the **PLAY** button. With Video CDs that have playback control, PBC is displayed, and a menu.

- Menus are recorded on discs. Menu displays differ with each disc

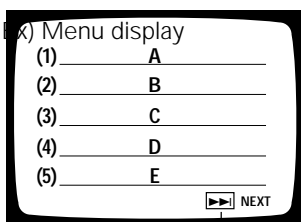

When there's another menu

3 When there's a following menu



Press the NEXT button.



return to the previous menu



Press the PREV button.

4 Select numbers in a menu using the number buttons

- Playback starts.

Ex) To select 3 → To select 10 →

To select 21 →

What's a Video CD?

It's a disc that delivers the MD sound quality and VHS picture quality. Thanks to digital signal compression technology (MPEG system), you can enjoy up to 74 minutes of continuous video and audio from a single disc. There are two kinds of Video CD. To control Video CD play, one kind of disc (Version 2.0) features a Playback Control signal (hereafter referred to as PBC). The other kind of disc (Version 1.1) does not feature a recorded PBC signal.

Video CD with no PBC (Version 1.1)

Video and audio play is possible with same operations as a CD.

Video CD with PBC (Version 2.0)
Menu display

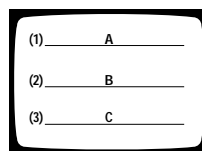

- Using on-screen menus enables easy play of interactive software and software with reference functions. You also get high-resolution video and still picture capability.

- You can enjoy these discs in the same way as discs with no PBC (Switch PBC OFF with the PLAYBACK CONTROL button.)

This product enables PBC play using the number, PLAY, Next, Previous, and RETURN buttons.

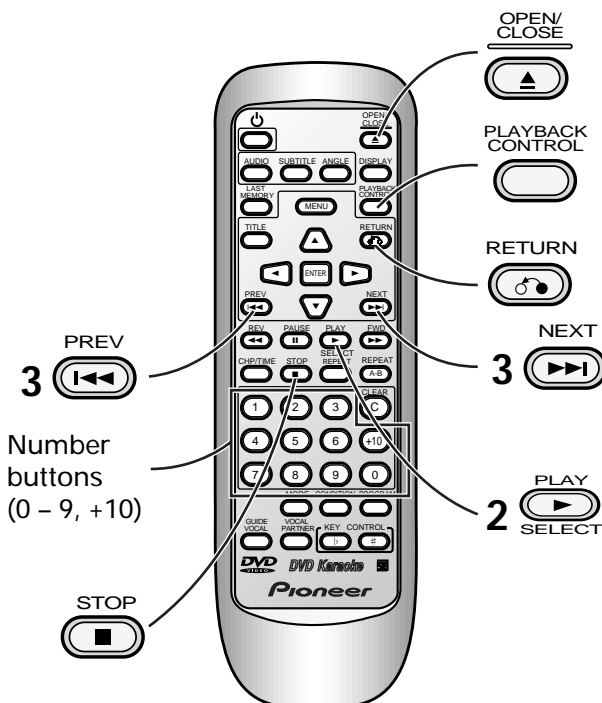

To stop the player



- Press the STOP button.



- Press the OPEN/CLOSE button.



- Press the PLAYBACK CONTROL button.



(In this case, playback control switches OFF, and the mode becomes that for playback of Video CDs with no PBC.)

With discs that have no PBC, play will not stop even if you press the PLAYBACK CONTROL button.

Tips

"RETURN" during Video-CD play with PBC

During Video-CD play with PBC only, the "STOP" button on the main unit functions as a "RETURN" button. At any other time, it functions as a "STOP" button.

Playing Video CDs (with PBC)

Displays shown when the **PLAY/SELECT** ►, **PREV** ◀◀, **NEXT** ▶▶, or **RETURN** ⏪ buttons are pressed.

Example of operation of a disc with PBC (Playback Control)

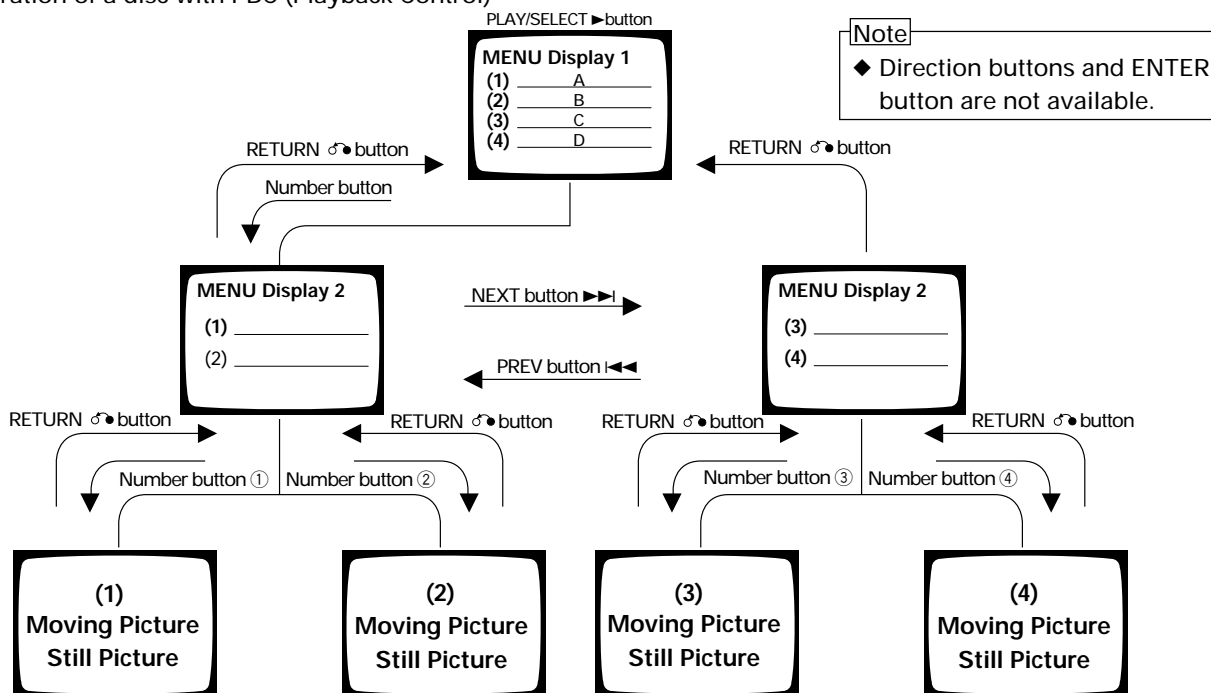

Menu operation

- Ⓐ Press the **RETURN** button to move back to the previous menu.



- Each time you press the button, you move back a menu. If you repeat pressing the button, you will eventually return to the first menu.

- Ⓑ Press the **▶▶** button to move to the next menu, or the **◀◀** button to move to the previous menu.



You can play Video CDs without using menu displays

- ① Press the **PLAYBACK CONTROL** button .

- The **PLAYBACK CONTROL** indicator on the front of the player goes out.

- ② Press the **PLAY** ► button, or select using number buttons.



Example) To select 10 **+10** → **10**

To select 21 **+10** → **+10** → **1**

The following are functions that do not operate when using menu operation with a Video CD that has PBC. (When **PBC PLAY** is lit in the display window)

- Track Skip Forward/Skip Back **P.13**
- Track/Time Search **P.21**
- Repeat **P.22**
- Stopping a song **P.28**
- Reservation **P.32**

Chapter (Track) Skip Forward/Skip Back

Skipping forward to the next chapter (track)

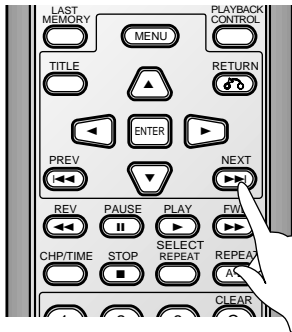

Press the **NEXT** $\blacktriangleright\blacktriangleright$ button.

- Press to skip forward to the next chapter (track).
- The $\blacktriangleright\blacktriangleright\blacktriangleright\blacktriangleright$ button on the front panel has the same function.

Fast forward

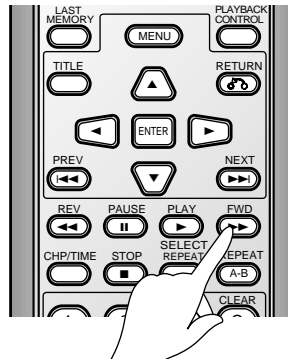

Press and hold the **FWD** $\blacktriangleright\blacktriangleright$ button.

- Release the FWD $\blacktriangleright\blacktriangleright$ button when you reach the desired location. Normal playback resumes.
- When you continue pressing the $\blacktriangleright\blacktriangleright\blacktriangleright\blacktriangleright$ button on the front panel of the main unit, it has the same function as the FWD $\blacktriangleright\blacktriangleright$ button on the remote control.

Skipping back to the previous chapter (track)

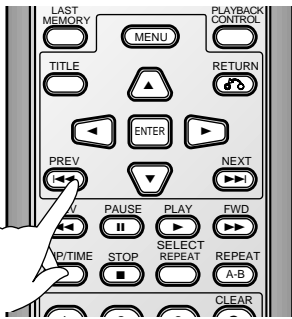

Press the **PREV** $\blacktriangleleft\blacktriangleleft$ button.

- Press once to skip back to the start of the chapter (track) currently playing.
- Press again to skip back to the start of the previous chapter (track).
- The $\blacktriangleleft\blacktriangleleft\blacktriangleleft\blacktriangleleft$ button on the front panel has the same function.

Fast reverse

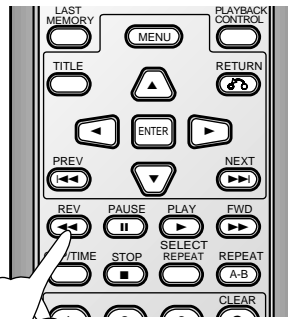

Press and hold the **REV** $\blacktriangleleft\blacktriangleleft$ button.

- Release the REV $\blacktriangleleft\blacktriangleleft$ button when you reach the desired location. Normal playback resumes.
- When you continue pressing the $\blacktriangleleft\blacktriangleleft\blacktriangleleft\blacktriangleleft$ button on the front panel of the main unit, it has the same function as the REV $\blacktriangleleft\blacktriangleleft$ button on the remote control.

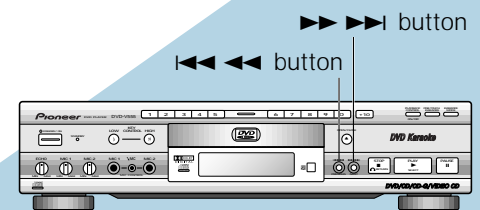
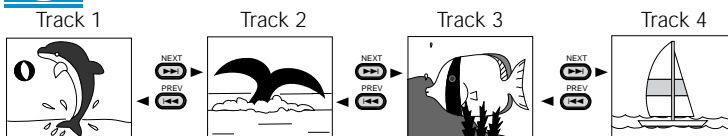
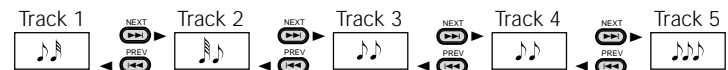
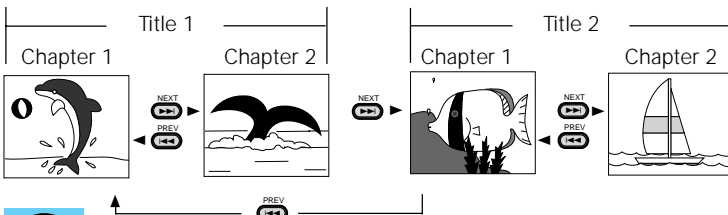

Stopping Playback & Switching Power OFF

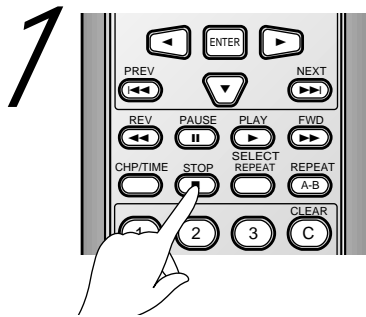

1 Press the STOP ■ button.

- On the front panel, press ■.
- Playback stops.

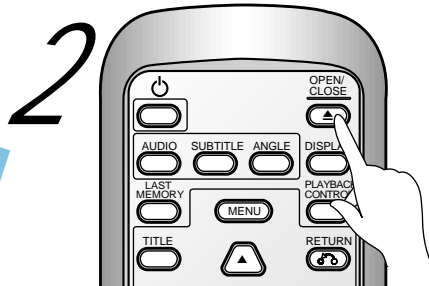

2 Press the OPEN/CLOSE ▲ button.

- On the front panel, press ▲.
- The disc table comes out.

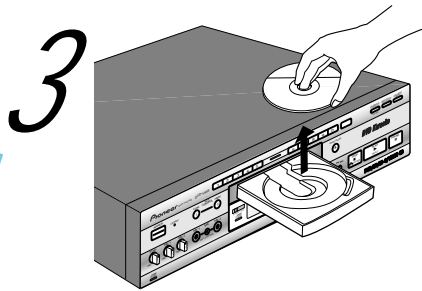

3 Remove the disc.

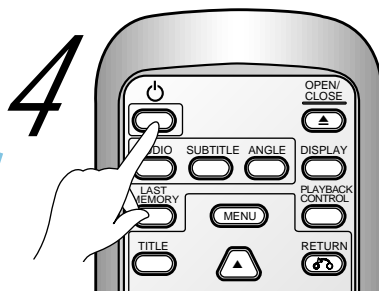

4 Press the STANDBY/ON button on the remote control unit.

- The disc table goes back in and the STANDBY indicator lights.

Note

- ◆ You can stop part way through and continue playback later from the point where you stopped. Refer to page 15.

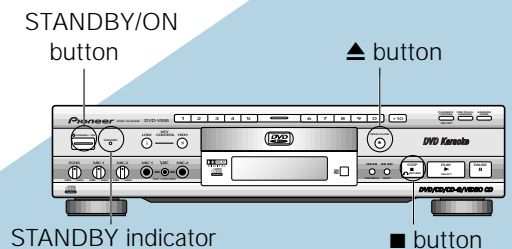

Continuing Playback from Where You Stopped

Memorizing the place where you stopped watching (LAST MEMORY)

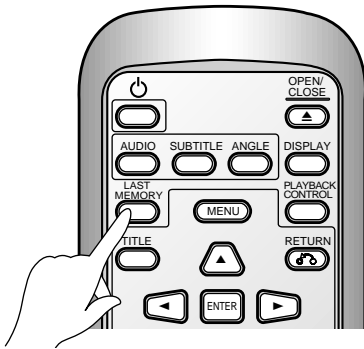

Press the LAST MEMORY button during play.

- The LAST MEMORY indicator lights on the player.
- Press the POWER button on the remote control unit to switch power OFF, or press the STOP ■ button to stop playback.



Tips

- Even with a disc you have memorized with LAST MEMORY, playback begins at the start of the disc if you press the PLAY ► button.
- When you continue playback from the point where you stopped, LAST MEMORY is automatically canceled for that disc.
- If you register more than five DVDs in LAST MEMORY, details of the latest disc are memorized, while details of the least recent disc (the disc you registered first) are erased.
- When a Video CD is ejected, memorized data will be cleared.
- In the case of DVDs, the Last Memory mode may not function for some titles.

Resuming playback from where you stopped

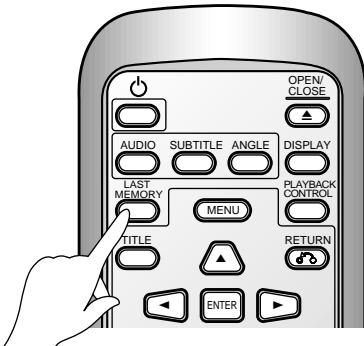

Press the LAST MEMORY button during STOP.

- When the power is turned off and a disc inserted, the power will be turned on and playback will start automatically.



Note

- ◆ This function is for playback of DVDs and Video CDs. You cannot use it with CDs.
- ◆ When there is a power outage, the power is turned off during playback, with the STANDBY/ON button on the main unit or you disconnect the player from the wall outlet while the power is ON, settings are cleared. Before disconnecting the power cord, press the STANDBY/ON button on the remote control to enter the unit to standby mode after distinguishing the " - OFF - " display, then press the STANDBY/ON button on the main unit.
- ◆ When PBC playback is engaged on Video CDs, continuous playback may not be possible.

LAST MEMORY indicator

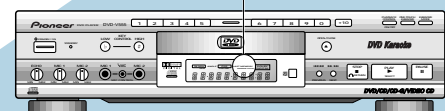

Detailed Operation

Playback by Menu Selection	18
Playing Back CD Graphics	19
Searching for a Desired Video Scene/Audio Track	20
Repeat Play	22
Still Frame	23

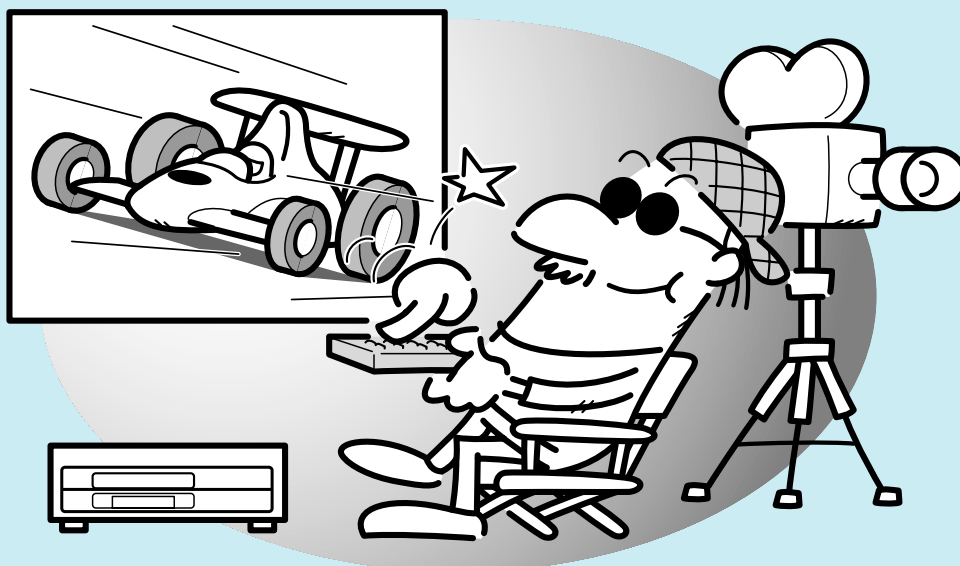

Playback by Menu Selection

DVDs and Video CDs, depending on the disc, feature selection menus. This player lets you choose a desired title or track by selecting from a menu.

Selection and playback from a menu

1 Press .

- A menu is displayed. This menu is recorded on the disc. Menus differ depending on the disc.
- With Video CDs (p. 11) that have Play Back Control, PBC is indicated in the display window.

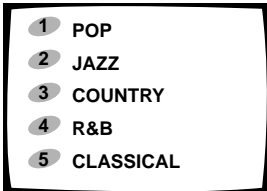

2 For example, to select ② JAZZ, press the ② number button.

- When selecting a number higher than 10, use the button.
- When selecting 10, press → .
- When selecting 17, press → .
- When selecting 20, press → → .
- The selected title or track starts playing.
- With DVDs, you can also select numbers with the and buttons and then press .

Tips

- Menu details differ depending on the disc. Play a disc by making menu selections using the direction buttons (, , , ,) and the number buttons.
- You can play Video CDs without using menu displays. Press the PLAYBACK CONTROL button on the main unit or remote control to switch "PBC" OFF.
- Depending on the title, you can also make a selection using a menu. To do this, press the when indications are displayed to call up a menu, and select the desired title.

Returning to menu display during playback

During DVD playback

1 Press .

2 Press .

- Press again for a menu of title contents.
- Operate according to disc menus.

During Video CD playback

Press .

Pressing the button during PCB playback will display the menu. With PBC playback, because the player's operation method and functions depend on the PBC signal recorded on the disc, they will differ according to the disc. For details, please refer to the disc's instruction manual.

Notes

- ◆ When playing a Video CD with a menu displayed, you cannot use Reserve play, Repeat play, and Track/Time Search functions. This is because interactive operation using the menu is possible.
- ◆ With Video CDs when PBC is ON, player operation differs depending on the disc. For details, read the instructions that come with the disc.
- ◆ With DVDs, menu indications may not be displayed.

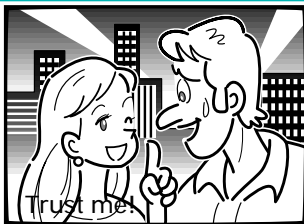

Playing Back CD Graphics

Video and audio information is recorded in different areas on a disc. There's also a subcode area where information such as subtitles and song lyrics can be recorded. Graphics refers to the reading of the signals in this area, and their display.

CD graphics bear the **GRAPHICS** mark. You can enjoy graphics when playing discs bearing this mark.

1 Perform steps 1 through 5 on page 10.

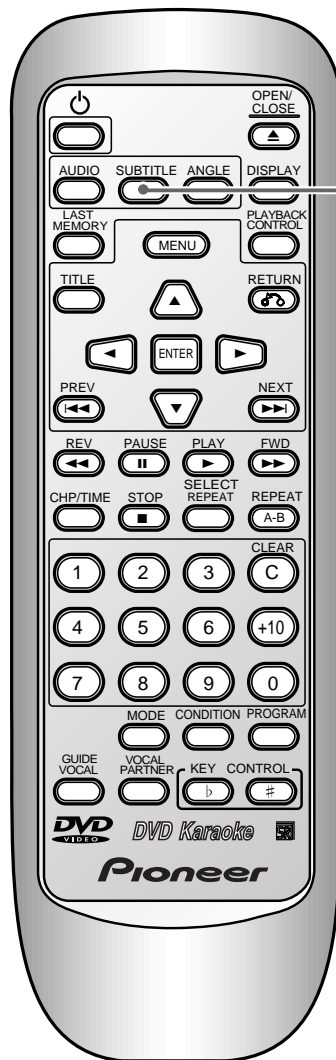

Switching graphics ON

2 Press **SUBTITLE**.

- The mode changes as follows.

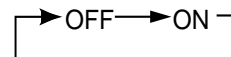

Switching graphics OFF

- When graphics ON, press **SUBTITLE**.

Notes

◆ **There should be graphics but...**

If you play CD graphics discs with the graphics mode switched ON, and still no graphics are displayed, the problem could be due to inappropriate graphics channel setting, or because the graphics display is in the wrong position on the screen. Refer to pages 39 and 40.

- ◆ When playing a disc with no graphics recorded on it in rare cases erroneous graphics may be displayed, but this does not mean the player is malfunctioning. When playing discs without recorded graphics, be sure to switch the graphics mode OFF.

Tips

During playback of CD graphics, performing the following operations may result in missing subtitles and picture and subtitle color changes, but this is not a malfunction. Wait a little, and normal graphics display resumes.

- Fast forward/reverse
- Pause, Search
- Switching graphics ON on the graphics control display
- Display a menu

Searching for a Desired Video Scene/Audio Track (Title Search) Part 1

Title 1

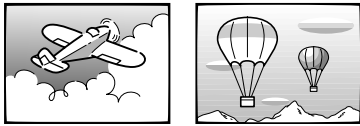

Title 2

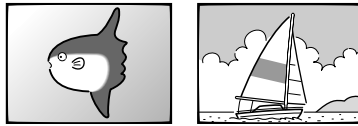

Title Number Search

You can select a title in these 2 ways.

(Method 1)

1 Press .

- Title number flashes on screen.

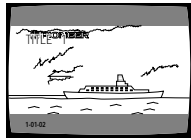

2 Press again.

- Continue pressing until you reach the desired number.

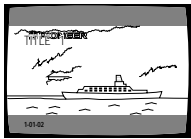

3 Press .

- Playback of the selected title starts.

(Method 2)

1 Press .

2 Select title numbers with the number buttons.

- When selecting title number 5, press .
- When selecting title number 10, press → .

3 Press .

- Playback of the selected title starts.

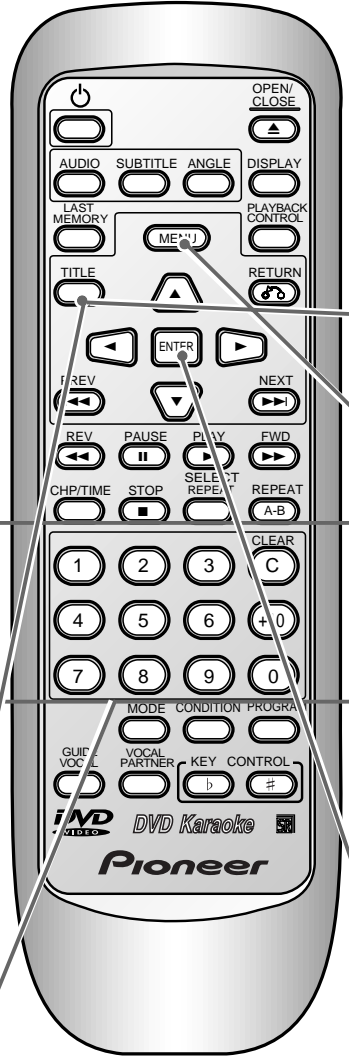

Search with Menu

- Operates during play only.

1 Press .

2 Press .

- Title menu is displayed. (May not be displayed with some discs.)

3 Select a title number using buttons.

- You can also make a direct selection using the number buttons. Your selected title soon starts playing.

4 Press .

- Playback of the selected title starts.

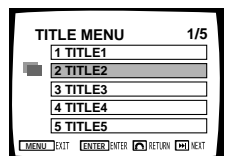
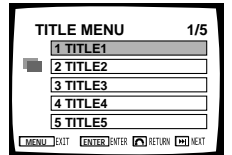

Notes

- ◆ Directly pressing the number buttons selects Title search and Chapter search. For details, refer to page 27.
- ◆ With certain DVDs, search operation may stop. In this case, the mark appears.
- ◆ Depending on the disc, menu may not be displayed.

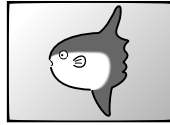
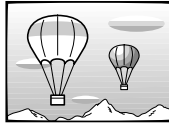

Searching for a Desired Video Scene/Audio Track (Chapter/Track Search) Part 2

Three ways to search a DVD or Video CD; normal search, direct search and time search are possible. For CD, direct search only is possible.

Chapter Number Search (Normal Search)

Direct search using the number buttons

Example 1: To select track number 3,



Example 2: To select track number 17,



- With DVDs, it becomes Title Search or Chapter search. For details refer to page 27.

When the Chapter/Track number is high

1 Press **CHP/TIME**.

- Chapter/Track number flashes.
- With DVDs, a menu may be displayed during the Stop mode. In this case, refer to "Chapter Number Search with Menu" on the right.

2 Specifying Chapter/Track numbers with the number buttons.

Example 1: Selecting Chapter/Track 31



Example 2: Selecting Chapter 187

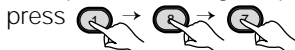

3 Press **PLAY SELECT**.

- The selected Chapter/Track starts playing.

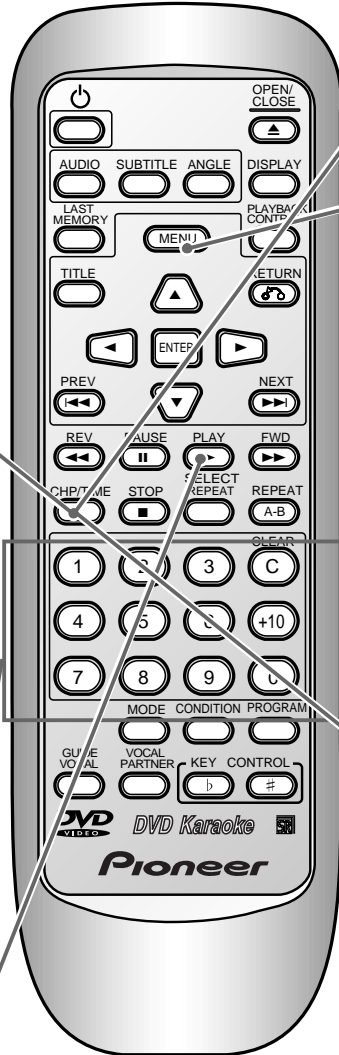

Chapter Number Search with Menu

You can perform this with DVDs only.

1 Press **CHP/TIME**.

- When in the Stop mode, proceed to step 3.

2 Press **MENU**.

- Chapter menu is displayed.

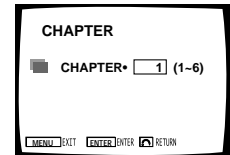

3 Make a selection following on-screen indications.

- With certain titles, there may be no menu display. In this case, perform the operations described at left.

Time Search

1 Press **CHP/TIME** twice.

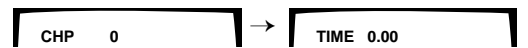

- With DVDs that have no chapters, time is displayed after pressing the button once.

2 Select the desired time number with the number buttons.

Example : To select 21 minutes 43 seconds,



- With DVDs, you cannot search for chapters that overlap titles.

3 Press **PLAY SELECT**.

- Playback starts from the selected elapsed play time or selected frame.

Notes

- ◆ Time Search is not possible with CDs.
- ◆ With DVDs, Search may not be possible with certain titles. In this case, the mark is displayed.
- ◆ When performing DVD or Video CD Time Search, playback may start from a slightly different time than that specified.
- ◆ When a DVD is not playing (in the STOP mode), Time Search is not possible.
- ◆ During Video CD PBC play, search operations described above are not possible.

Tips

- To clear Title or Chapter/Track/Time/Frame indications when they are flashing, press the CLEAR button twice.
- Depending on the title, you can also make a selection using a menu. To do this, press the **MENU** when indications are displayed to call up a menu, and select the desired title.

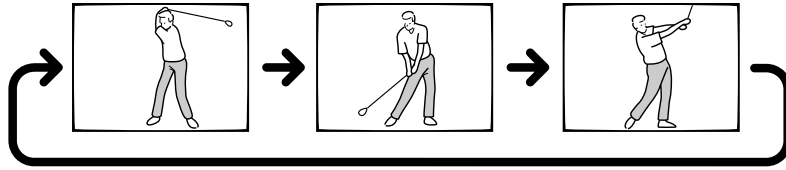

Repeat Play

Repeat play of a chapter/track

Press **REPEAT** once during playback of the chapter or track you want to repeat.

Repeat play of a title

Press **REPEAT** twice during playback of the title you want to repeat.

- With DVDs, the title continues playing until the end, and then playback starts once more from the beginning of that title.
- With CDs and Video CDs, a disc is title, so the entire disc is repeated. In this case, display window shows "R_SID".

Repeat play of a specified section

Press **REPEAT A-B** at the beginning and end of the section you want to repeat.

Return to a specified location

1 Press **REPEAT A-B** at the desired location.

2 When you want to return, press **PLAY SELECT**.

- Press **CLEAR C** to clear a specified location.

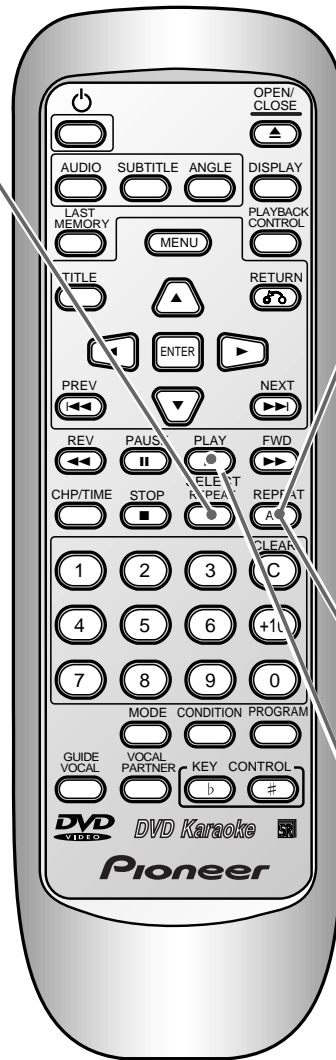

Tips

- Press **CLEAR C** to cancel Repeat play. The Repeat play mode is canceled, but playback continues.
- With DVDs, repeat playback between titles is not possible.

Note

- ◆ With some DVD discs, there may be times when Repeat playback is not possible because of the title.
- ◆ With Video CDs, Repeat play is not possible during playback with the menu displayed (PBC playback). You can play Video CDs with-out using menu displays. Press the **PLAYBACK CONTROL** button on the main unit or the remote control to switch "PBC" OFF.
- ◆ The Repeat key does not function during Reserve play.

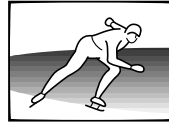
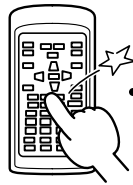
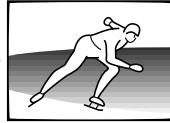

Still Frame

Basic Operation

Detailed Operation

Karaoke Operation

Setting

Set-Up

Other Information

Viewing a still frame

Press .

- Press the PAUSE button on the front of the player.

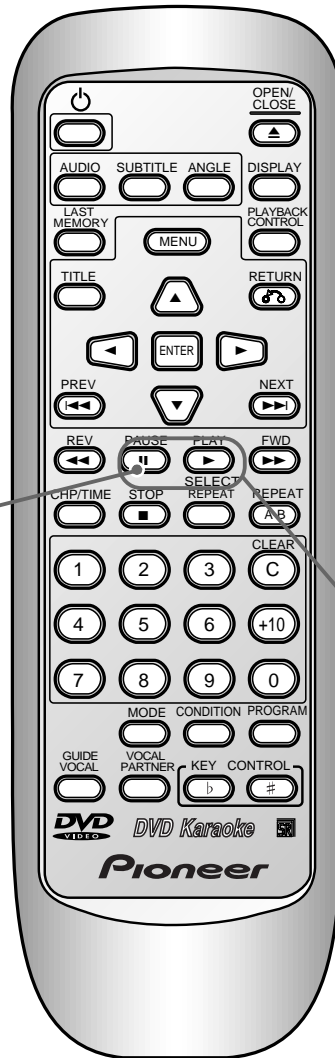

To return to normal playback

Press or .

- Press the PLAY button or PAUSE button on the front of the player.

Notes

- ◆ There is no sound when viewing still frames.
- ◆ Pause may not be possible with certain discs. In this case, the mark is displayed.

Karaoke Operation

Karaoke Entertainment	26
Adjusting to Create the Desired Sound	29
Echo adjustment	29
Changing performance key	29
Operation is possible with the MIC	29
Convenient Function for Practicing Karaoke	30
Reserving a Desired Song	32
Sing with Professional karaoke (Guide melody)	33

Basic
Operation

Detailed
Operation

Karaoke
Operation

Setting

Set-Up

Other
Information



Karaoke Entertainment

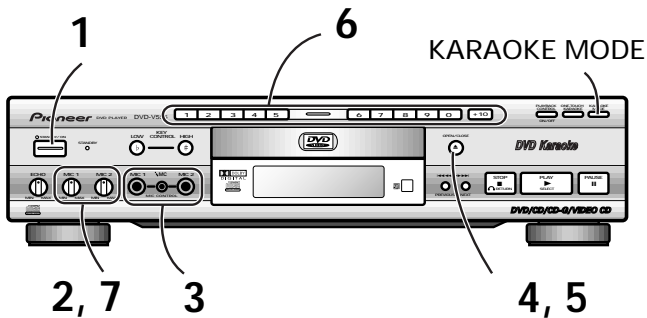

Let's sing!!

1 Press the **STANDBY/ON** button.

- The **KARAOKE MODE** button lights, and the mode becomes **KARAOKE**.

2 Set **MIC 1** and **MIC 2** volume level knobs to "Min".

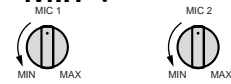

3 Connect the microphone, and switch **ON**.

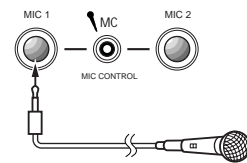

- When the separately sold microphone with control function is used, key control and "once more" can be operated. Please refer to page 29.

4 Press the **OPEN/CLOSE** button.

- The disc table comes out.

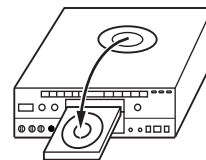

Load a DVD/CD/CD-G Video CD

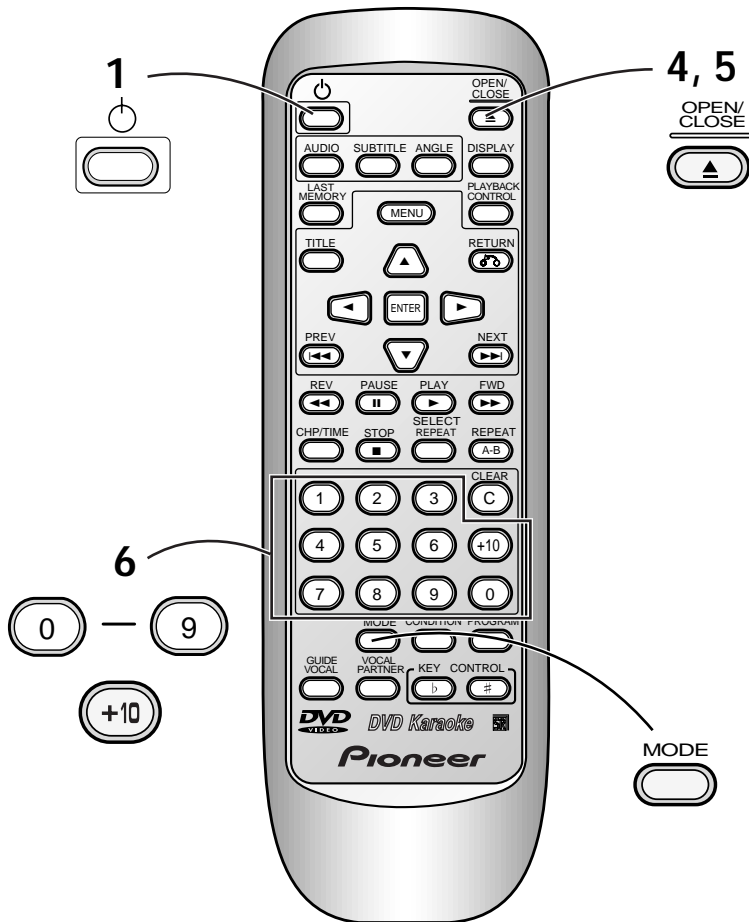

Tips

To change the mode
Each time you press the **KARAOKE MODE** button, the setting changes as follows.

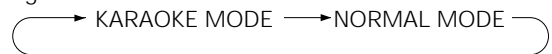

- When the **KARAOKE MODE** button lights, skip this step.
- When the **KARAOKE** mode is selected, no digital signal is output from this unit's **DIGITAL OUT** jacks. An audio signal is output from the **AUDIO OUT** jacks only.

5 Press the OPEN/CLOSE ▲ button.

- The disc table goes back in.

6 Select desired songs using the number buttons.

(Example) Track 3 , track 21

Remote control operation

(Example) Track 3

Track 21 → →

7 Turn the MIC volume level knob to adjust volume level.

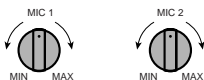

- Adjust overall volume level with the TV or amplifier.



Note

- ◆ During PBC play of Video CDs with PBC (see page 11), after performing steps **1** through **5**, press the Play ► button, and then perform step **6**.

Tips

Howling

If sound from the speakers is picked up by a MIC and output again through the speakers, the result is a screeching sound known as "howling". Perform the following steps to eliminate howling.

- (1) Move the MIC away from speakers.
- (2) Turn the MIC volume knob counterclockwise to lower the volume level.
- (3) Turn the Digital Echo level knob (P.29) counterclockwise to lower the echo level.

Display between songs

(With DVDs, CDs, and Video CDs.)

When in the KARAOKE MODE (when the KARAOKE MODE indicator on the front panel is lit), during pause or when a disc has stopped playing, an karaoke bird characters are displayed.

When no discs loaded



Automatic DVD detection function

On some DVD karaoke discs, track numbers are indicated by title numbers, while on other DVD karaoke discs, track numbers are indicated by chapter numbers. When this player's DIRECT SEARCH mode is set to AUTO, these kinds of DVDs are automatically detected, and tracks can be selected using the number buttons.

However, auto detection of some discs is not possible. In this case, set the DIRECT SEARCH mode to match the DVD track number type (Title or Chapter).

- (1) when there is a DVD loaded in the player (in the stop or play mode), press the remote control MODE button.
 - (2) Select TITLE or CHAPTER using the remote control ◀, ▶ buttons, and press ENTER.
- When you eject a disc, the DIRECT SEARCH mode returns to the AUTO setting.

DIRECT SEARCH
AUTO TITLE CHAPTER

Guide melody function (see page 33)

With DVD karaoke discs featuring a recorded guide melody, you can switch GUIDE MELODY ON or OFF.

- (1) Press the remote Control MODE button 3 times.
- (2) Switch GUIDE MELODY ON or OFF using the remote control ◀, ▶ buttons.

GUIDE MELODY
ON OFF

Stopping a song

When the KARAOKE MODE is selected (the KARAOKE MODE indicator lights), play pauses after a selected song finishes (SINGLE PLAY mode).

If you cancel pause between songs with the following procedures, play continues, without the Pause or Stop function operating, even if a song finishes playing.

1 Press the MODE button and select "SINGLE MODE"

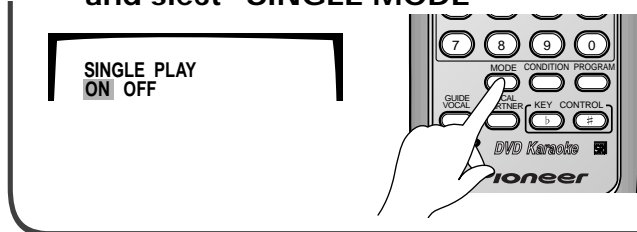

2 Select OFF with the ◀ ▶ buttons.

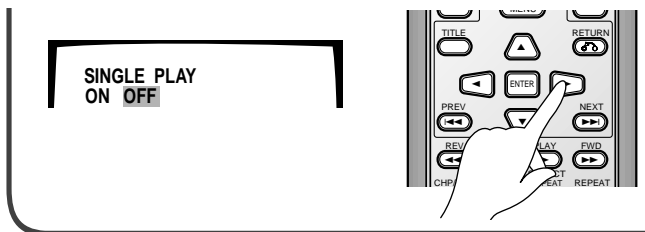

Tip

When the input switch function is set to "NORMAL", the mode becomes Continuous play.

Notes

- ◆ With DVDs, some discs may have a Menu function. With this kind of disc, since operations are in line with menu selections, there is no SINGLE PLAY mode, and no entertaining display between songs.
- ◆ When playing a Video CD with Playback Control ON (see page 11), you cannot select the SINGLE PLAY mode.

Adjusting to Create the Desired Sound

Basic Operation

Detailed Operation

Karaoke Operation

Setting

Set-Up

Other Information

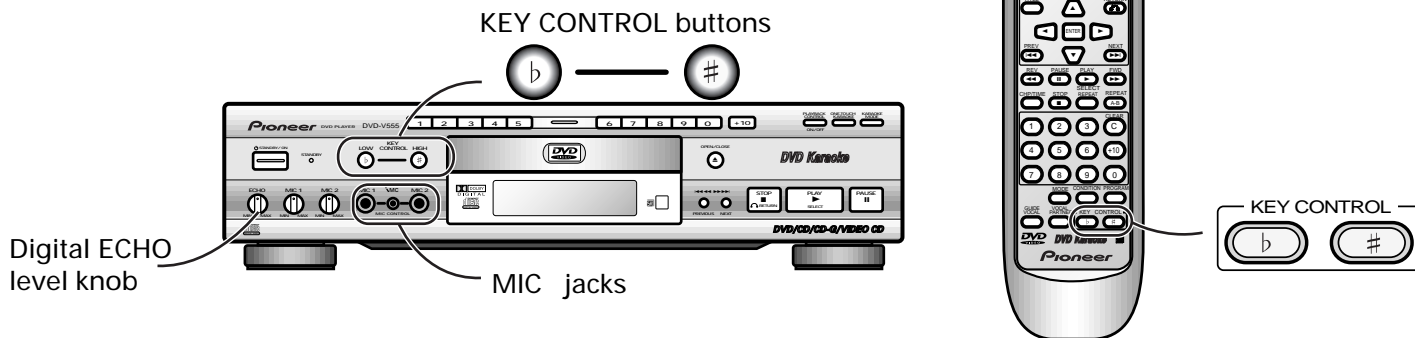

Echo adjustment

Adjust with the Digital Echo level knob.

Tip



Depending on the room, there may be howling if the echo level is too high (see page 27).

Operation is possible with the MIC

You can operate Key control and Once more.

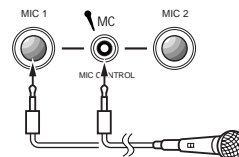
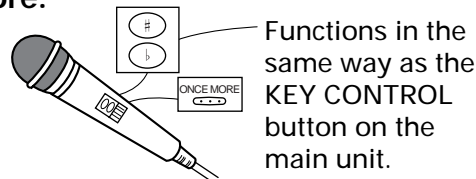

- You can perform these operation with the separately sold DM-920 and DM-820. Refer to the MIC's User's Manual for details concerning Key control operation.
- The MICrophone operation button operates only when the control plug of the MICrophone is connected to the MIC CONTROL jack and the MIC switch is set to ON.

Changing performance key

Press a KEY CONTROL button.



Each button can be used to lower or raise the key in 5 steps.

Low: The key is lowered
High: The key is raised

Tip

- When you play song to the end, or if you press the STOP button during play, the key returns to the standard setting. However, with certain discs, this may not happen. (When displaying a DVD disc menu)

Tips

- Once more
- Each time you press this during play, you move back a little from the point you are in the song and the video.
 - You can use this to repeat difficult sections in songs you are singing for the first time.
- Once more operation may not be possible with some discs.

Convenient Functions for Practicing Karaoke

You can practice karaoke with or without a guide vocal.

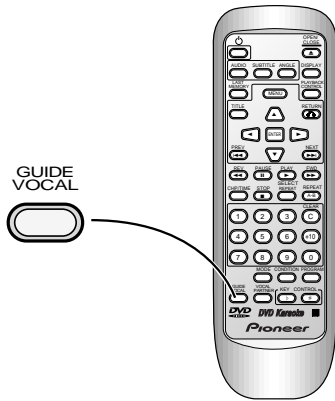

Guide vocal

<With DVDs>

Press the GUIDE VOCAL button.



- If the disc provides only Guide vocal 1(or 2) , switching is between ON and OFF.
- Some discs have Guide vocal 1 and Guide vocal 2 recorded on them. The selected vocal changes each time you press the button as follows.

Guide Vocal Selection	Display
① Guide vocal 1 and 2	(VOCAL 1&2)
② Guide vocal 1	(VOCAL1)
③ Guide vocal 2	(VOCAL2)
④ Guide vocal1&2(mix)	(VOCAL MIX)
Off	(VOCAL OFF)

<With Video CDs and CDs>

Press the GUIDE VOCAL button.



- When Guide Vocal is ON, "G-VO" appears in the display.
- Switch it OFF, and "G-VO" disappears from the display.
- You can adjust GUIDE VOCAL volume level with the ◀ , ▶ button. With CD and Video CD multiplex discs, you can adjust vocal volume level. If you cannot adjust GUIDE VOCAL volume level, press the GUIDE VOCAL button once more.

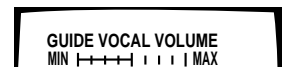

- After you have adjusted volume level, it doesn't change until you switch power to the player OFF. To change the volume level, press the GUIDE VOCAL button, switch GUIDE VOCAL OFF once, switch it ON again, and then adjust the volume level.

Tips

- Pressing the GUIDE VOCAL button has no effect if the disc you are playing does not have a guide vocal recorded on it (it must be a multiplex disc). With this kind of disc, do not press the GUIDE VOCAL button.
- With vocals 1 and 2 in ①, Guide vocal 1 is output through the left channel, and Guide vocal 2 is output through the right channel. With the mixed vocals in ④, output of Guide vocals 1 and 2 is monaural.

Convenient Functions for Practicing Karaoke

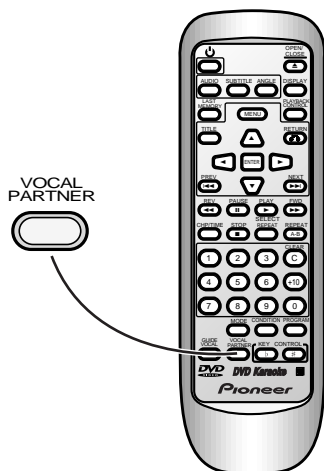

Vocal partner

With this function, when you sing, the recorded singer's voice cuts out. If you stop singing, the singer's voice cuts back in. This is a handy function when practicing new songs and duets alone.

<With DVDs >

Press the **VOCAL PARTNER** button.



- To switch OFF, press the button again.

<With multiplex karaoke CDs and Video CDs >

Press the **VOCAL PARTNER** button twice.

- To switch OFF, continue pressing the button until the indicator disappears.
- With CDs and Video CDs, the mode changes as follows when you press the VOCAL PARTNER or ONE-TOUCH KARAOKE buttons.

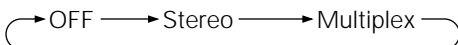

Tips

- You can change the vocal partner volume level with the Direction buttons (◀▶) by displaying "VOLUME" on the screen by pressing the GUIDE VOCAL button.
- With some discs, even when you sing, the recorded singer's voice volume level does not decrease.
- With DVDs, the VOCAL PARTNER function operates with the Guide vocal selected with VOCAL PARTNER button.



One - Touch karaoke

<With multiplex karaoke Video CDs and CDs >

When One-Touch Karaoke and Vocal Partner are OFF, and you can hear a Guide Vocal from the right channel, press the **ONE-TOUCH KARAOKE** button twice to switch it OFF.

Press the **ONE-TOUCH KARAOKE** button twice.



- To switch OFF, continue pressing the button until the indicator goes out.

<With Video CDs, CDs and DVDs >

When One-Touch Karaoke and Vocal Partner are OFF, and you can hear a Guide Vocal from the left and right channels, press the **ONE-TOUCH KARAOKE** button once to switch it OFF.

Press the **ONE-TOUCH KARAOKE** button once.

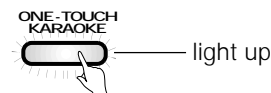

- To switch OFF, continue pressing the button until the indicator goes out.

Tip

- This function may not be very effective with some discs .

Reserving a Desired Song

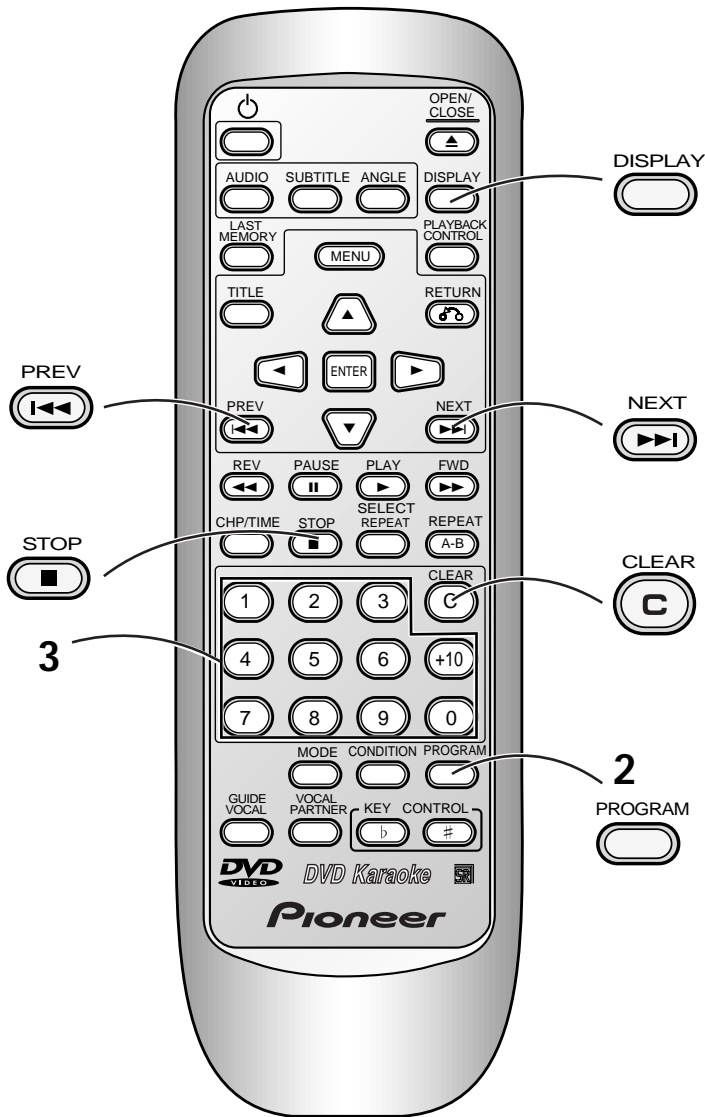

1 For karaoke fun, perform steps **1** through **5** on page 26.

2 Press the PROGRAM button.

- When reserving a song is possible, the indication on the right is displayed.

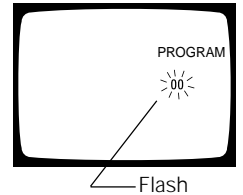

3 Select a song number with the number buttons.

Example: Reserving song number 9
Input a Title or Chapter number with DVDs, and a Track number with CDs and Video CDs. (Refer to p.21)



4 Repeat steps **2** and **3** to reserve other songs.

- Up to 24 songs can be reserved.
- Reserved songs play one after the other, without SINGLE PLAY pauses between them.
- When the reserved songs have played, reservation details are erased from memory in the order in which songs were reserved.
- When the last reserved song starts playing, the player pauses or stops and the program is canceled.
- Press the Next button, and the next reserved song starts playing. Even if you press the Previous button, you do not return to the previous reserved song. Instead, you return to the start of the currently playing song.

5 Adjust MIC 1 and 2 volume level.

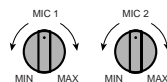

Note

With DVDs, the player determines automatically whether the disc is played according to titles or chapters. When the player has determined that a DVD cannot be programmed, cancel the program and play the disc normally.

Tips

- With Video CDs (Version 2.0 with PBC), if you do not switch Playback Control OFF with the remote control or on the main unit (the PLAYBACK CONTROL indicator on the front panel goes out), you cannot reserve a song. (Refer to page 11)
- If you reserve a song during play, the reserved song starts playing after the current song finishes.
- With Video CDs (Version 2.0 with PBC), pressing the PROGRAM button stops the disc and forcibly turns off PBC.

To stop playback.



Press the STOP button.

To confirm reservation details



Press the DISPLAY button.

- Press the button once more, and the display is switched OFF.

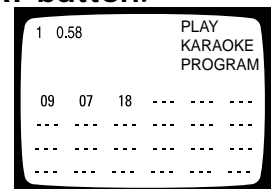

Sing With Professional Karaoke (Guide melody)

You can switch GUIDE MELODY ON/OFF With it switched ON, You can enjoy singing along with a professional singer.

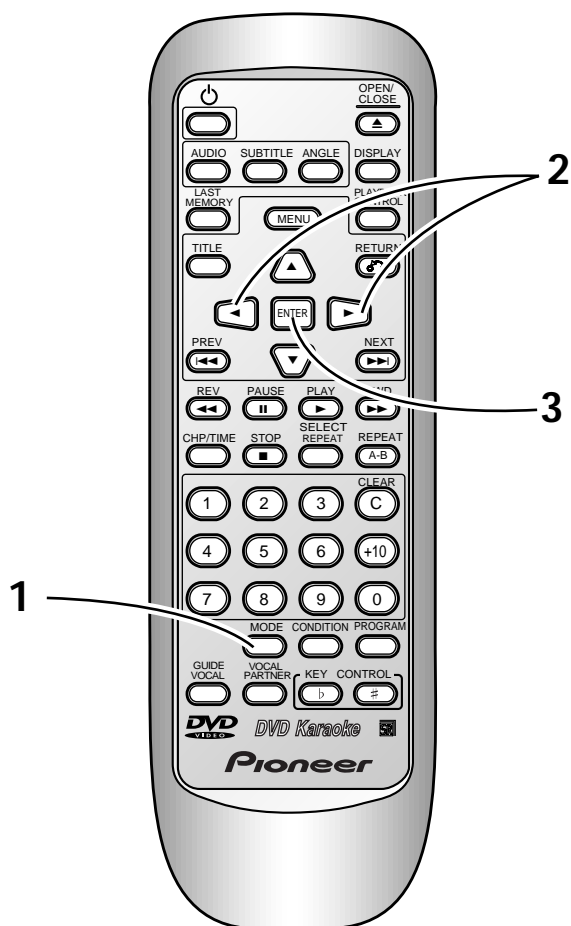

1 Press the **MODE** button on the remote control unit 3 times to select **GUIDE MELODY**.

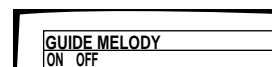

2 Press the Direction buttons (◀ ▶) to select "ON".

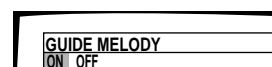

3 Press the **ENTER** button.



To cancel GUIDE MELODY

- 1 Perform steps 1 and 2.
- 2 Select "OFF" in step 2.
- 3 Press the ENTER button.

Tips

- When you switch the power to the unit ON, GUIDE MELODY switches ON.
- With discs that do not feature a separately recorded guide melody, "GUIDE MELODY" is not displayed.

Basic Operation

Detailed Operation

Karaoke Operation

Setting

Set-Up

Other Information

Setting

Multi-Aspect Setting for Wide Screen TV Software	36
Changing Picture, Sound Quality and Graphics Settings	38
Memorizing Settings for Often Viewed DVDs (Condition Memory)	42
Selecting Languages (Multi-Language)	43
Changing Audio Type	43
Selecting a Subtitle Language (Multi-Language Subtitles)	44
Viewing from a Desired Camera Angle (Multi-Angle)	44
Viewing Disc Information	45
Outline of GUI (Graphical User Interface) Operation	46
Changing Settings	52
How to Set Basic Audio and Subtitles	55

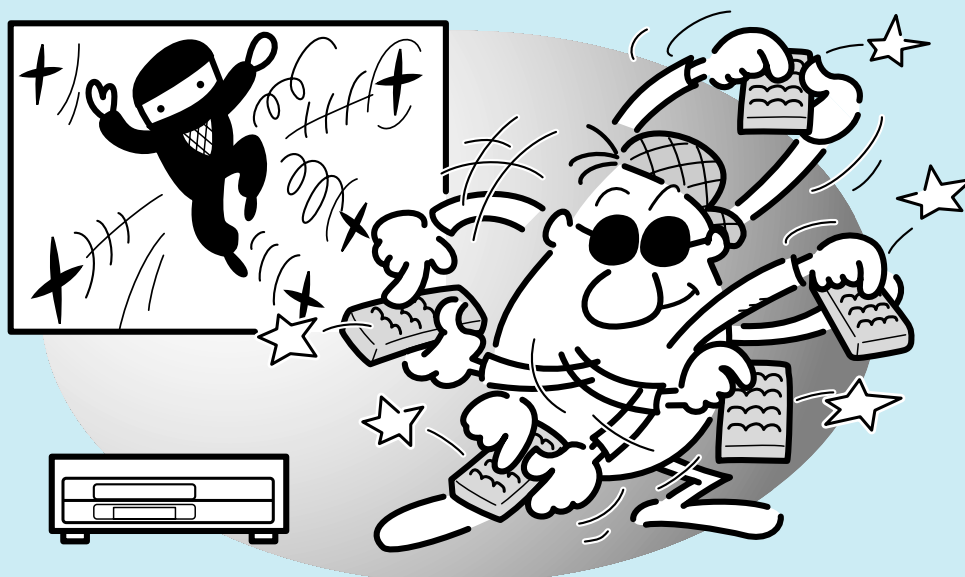

Multi-Aspect Setting for Wide Screen TV Software

Certain DVDs feature image data recorded with the "squeeze" recording system for wide screen viewing. When watching this kind of DVD on a conventional TV, the picture may appear vertically squeezed. If this occurs, you can use the Multi-Aspect function to achieve a normal picture.

1. Press **MENU** during stop.

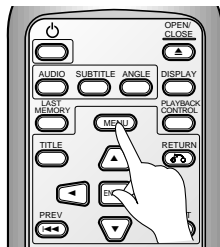
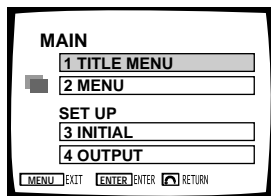

- The set-up menu is displayed.
- At the time of karaoke mode, the item "4. OUTPUT" is not displayed.

5. Press **ENTER**.

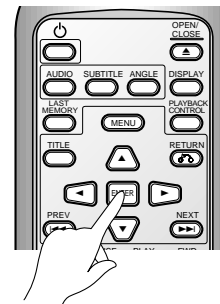
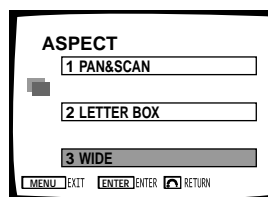

2. Select initial set-up with **▲ ▼**.

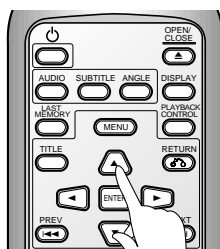
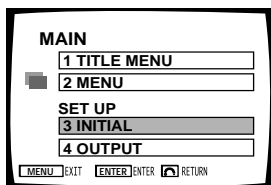

- The initial set-up button will be displayed in blue.

6. Select the desired mode (PAN & SCAN, LETTER BOX, WIDE) with the **▲ ▼** buttons.

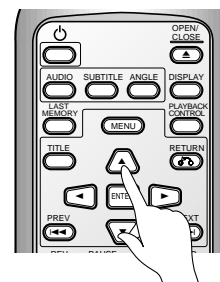
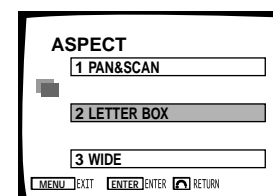

3. Press **ENTER**.

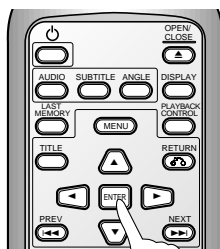
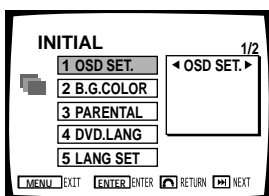

- The initial set-up screen will be displayed.

4. Select ASPECT using **▲ ▼** buttons.

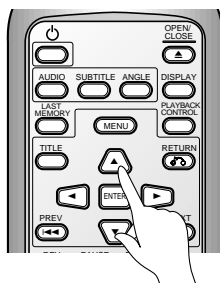
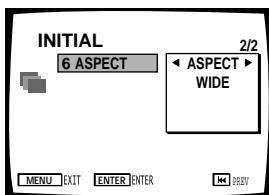

- Pressing and holding the **▼** button will display the next page's screen shown above.

7. Press **ENTER**.

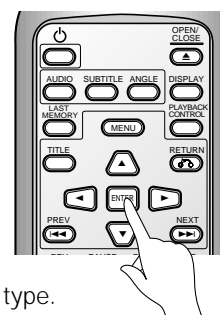

- The picture changes to the desired type.



Multi-Aspect Setting for Wide Screen TV Software

For DVDs where aspect switching is possible, select the aspect that matches the TV.

Disc	Aspect selection	Wide TV (16:9)	Regular TV (4:3)
(16:9)	Wide		
	Pan & scan		
	Letter box		
(4:3)			

When the above chart's  is selected, the picture with the correct height to width ratio will be selected. Whether aspect can be switched or not depends on the disc. Please refer to the information written on the disc's jacket etc.

For discs where aspect selection is not possible, make the screen adjustment using the TV's controls.

Note

- ◆ When there is a power outage, the power is turned off during playback, with the STANDBY/ON button on the main unit or you disconnect the player from the wall outlet while the power is ON, settings are cleared. Before disconnecting the power cord, press the STANDBY/ON button on the remote control to enter the unit to standby mode after distinguishing the " - OFF - " display, then press the STANDBY/ON button on the main unit.

Tips

- The width-to-height ratio of conventional TVs is 4:3, while the width-to-height ratio of wide screen and Hi-Vision TVs is 16:9. This width-to-height ratio is called the aspect ratio.

Basic
Operation

Detailed
Operation

Karaoke
Operation

Setting

Set-Up

Other
Information

Changing Picture, Sound Quality and Graphics Settings

The setting changes as follows according to how many times the  button is pressed.

NORMAL MODE Example : DVD

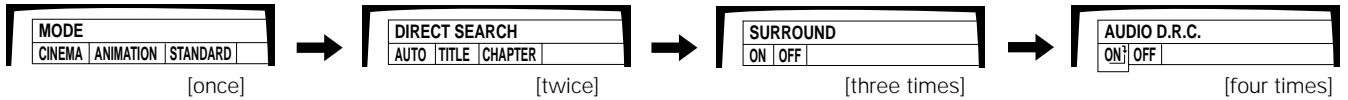

Disc \ Press	once	twice	three times	four times
DVD	MODE	DIRECT SEARCH	SURROUND	AUDIO D.R.C.
Video CD	MODE	SURROUND	---	---
CD	GRAPHIC	SURROUND	---	---

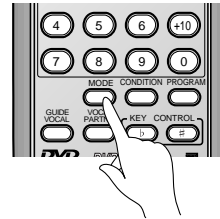

KARAOKE MODE Example : DVD

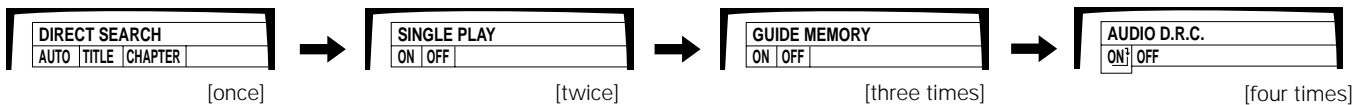

Disc \ Press	once	twice	three times	four times
DVD	DIRECT SEARCH	SINGLE PLAY	GUIDE MELODY	AUDIO D.R.C.
Video CD	SINGLE PLAY	---	---	---
CD	GRAPHICS	SINGLE PLAY	---	---

Note

- ◆ GUIDE MELODY is not displayed when playing discs that do not feature a guide melody.

Changing picture quality (Cinema Mode/Animation Mode)



This lets you select the ideal picture quality for watching regular movies, animation movies, and other video material.

1. During playback, press  to select "MODE".

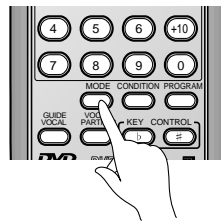
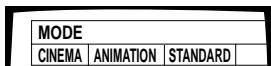

CINEMA

Picture quality: Provides a sharp, clear black picture for images with high contrast.

ANIMATION



Picture quality: Provides images with bright, clear colors.

STANDARD

Returns you to normal picture quality and display.

Note

- ◆ Depending on the contents of the software and the TV used, the picture may be unclear. In this case, switch to the Standard mode.

2. Select the desired mode with the   buttons.

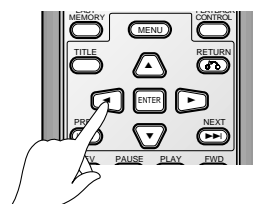

Changing CD graphics settings



Video and audio information is recorded in different areas on a disc.

There's also a subcode area where information such as subtitles and song lyrics can be recorded. Graphics refers to the reading of the signals in this area, and their display.

You can set the graphics channel (between 0 and 15) to select the desired information for display, and set the Scroll setting (from Normal to Step 17) to select the on-screen position of graphics indications.

4 Press **ENTER** button.

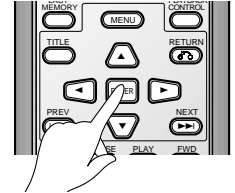
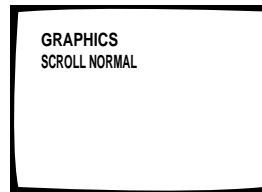

5 Select display position with the **▲ ▼** buttons.

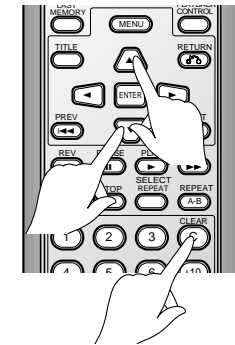
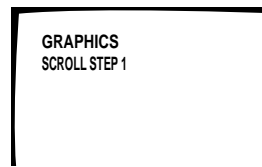

- You can select from 18 positions between Normal and Step 17.
- To return to the normal display position, press CLEAR button.

6 Press **ENTER**.

Graphics are displayed in the selected position.

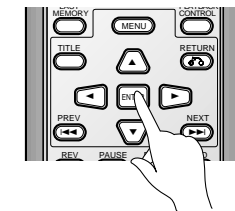

Changing graphics display position

1. During playback, press **MODE** and select **GRAPHICS**.

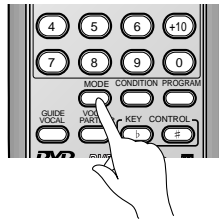
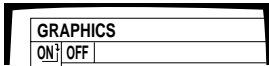

2. Select "ON" with the **◀ ▶** buttons.

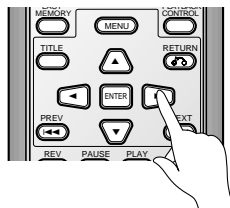
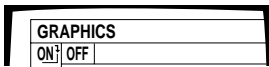

3. Press **ENTER** button.

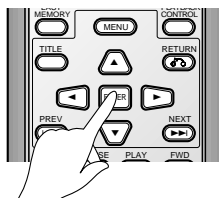

"SCROLL" flashes.

Note

If graphics are not displayed even if you perform these operations, try changing the channel (refer to page 40)

Tips

To return to the previous display the RETURN button on the remote control.

Basic Operation

Detailed Operation

Karaoke Operation

Setting

Set-Up

Other Information

Changing Picture, Sound Quality and Graphics Settings

Changing graphics channel

1. During play, press  and select **GRAPHICS**.

GRAPHICS
ON OFF

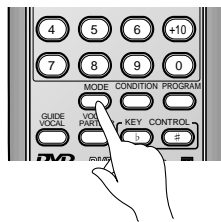

5 Press  button.

GRAPHICS
CHANNEL

00	01	02	03
04	05	06	07
08	09	10	11
12	13	14	15

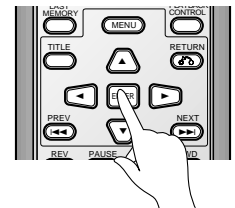

2. Select "ON" with the   buttons.

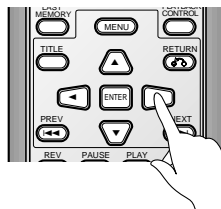

GRAPHICS
ON OFF



6 Select a channel number with the number buttons.

GRAPHICS
CHANNEL

00	01	02	03
04	05	06	07

- The selected channel number is displayed in reverse.
- Pressing the same number again switches it OFF.
- To select channel numbers 10 through 15, first press  and then  through .

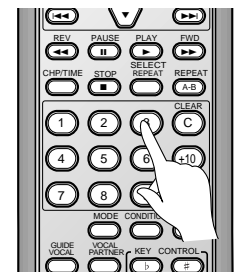

3. Press  button.

GRAPHICS
SCROLL
CHANNEL

"SCROLL" flashes.

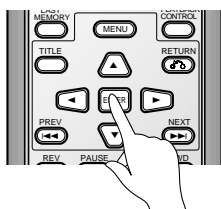

4 Select "CHANNEL" with the   buttons.

GRAPHICS
SCROLL
CHANNEL

"CHANNEL" flashes.

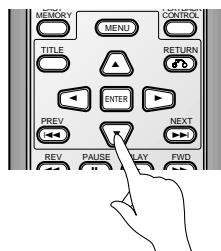

7 Press  button.

The selected channel's graphics are displayed.

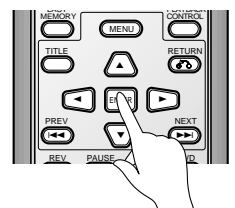

Note

If graphics are not displayed even if you perform these operations, try changing the position (refer to page 39)

Tips

- If power to the player is cut, changed graphics scroll and channel setting return to the initial settings. This is to prevent problems such as no display of graphics occurring when a different disc is played.
- To return to the previous display the RETURN button on the remote control.

Changing Sound quality (AUDIO D.R.C.)



AUDIO D.R.C. stands for Audio Dynamic Range Compression. DVDs provide sound with wide dynamic range. Switch AUDIO D.R.C. ON if you find dialog or other sounds hard to hear when listening on your stereo system or TV.

1. During playback, press the **MODE** button to select "AUDIO D.R.C."

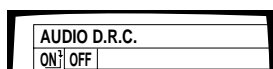

4. Adjust the amount of change with the **PREV** and **NEXT** buttons.

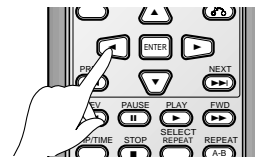
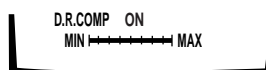

2. Select "ON" or "OFF" with the **PREV** and **NEXT** buttons.



5. Press **ENTER**.

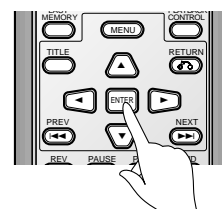

3. Press **ENTER** when "ON" is selected.

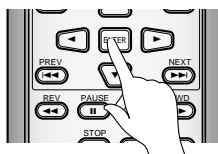
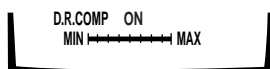

Tips

If **PREV** or **NEXT** is pressed during step 4, change will be in the order of "ON" or "OFF".

Changing to Surround



This function can only be used when in the NORMAL MODE. This operates only for the output from the AUDIO OUT terminal. It does not operate for the DIGITAL OUT terminal.

1. During playback, press the **MODE** button to select "SURROUND."

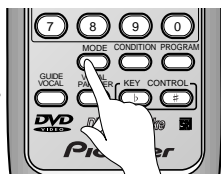
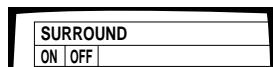

3. Press **ENTER**.

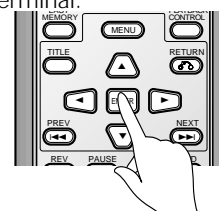

2. Select "ON" or "OFF" with the **PREV** and **NEXT** buttons.

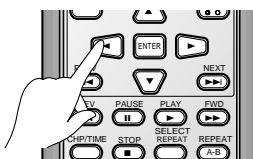



Memorizing Settings for Often Viewed DVDs (Condition Memory)

You can store settings for DVDs you often watch in memory. Settings remain in memory even if you remove the disc from the player, or switch power to the player OFF. If you load a disc that has its settings memorized, the Condition indicator lights. When you start playing the disc, the memorized settings are automatically recalled.

You can memorize details for the following nine settings. Once memorized, Condition Memory will automatically recall the settings.

- Direct search (page 21)
- Karaoke mode/Normal mode (page 26)
- Multi-Aspect (page 36)
- Cinema mode/Animation mode (page 38)
- Multi-language (page 43)
- Multi-language subtitles (page 44)
- Multi-Angle (page 44)
- Position (page 53)
- Parental level (page 53)

When a disc that has memorized settings is loaded...

"COND. MEMO" will appear on the screen, and the previously memorized settings will be selected.

Erasing the recorded contents

Load the disc that has memorized settings, and press the  button during "COND. MEMO" has been displayed. The disc's recorded data will be erased.

Tips

- Settings are stored in memory for use any time.
- You can store settings for up to 30 DVDs in memory. If you memorize settings for more than 30 DVDs, previously memorized settings are erased in order from the least recently memorized settings. After that, if you try to call up these previously memorized settings, you will get the latest settings that have taken their place.
- To make changes to Aspect ratio, Cinema mode/Animation mode, subtitle language, and language settings, press  during playback.
- Switching of the multi-audio mode etc., is automatic on some discs.

Press  during playback.

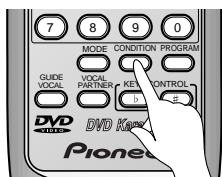

- "COND. MEMO" will appear on the TV screen.

Note

- ◆ When there is a power outage, the power is turned off during playback, with the STANDBY/ON button on the main unit or you disconnect the player from the wall outlet while the power is ON, settings are cleared. Before disconnecting the power cord, press the STANDBY/ON button on the remote control to enter the unit to standby mode after distinguishing the "- OFF -" display, then press the STANDBY/ON button on the main unit.



Selecting Languages (Multi-Language)

Dolby Digital, PCM, and other audio data is recorded on DVDs in a number of languages, letting you choose the desired language.

1. Press during playback.

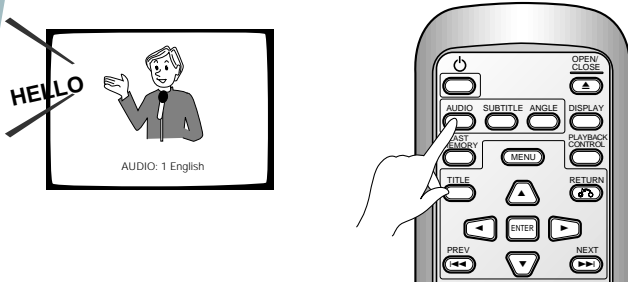

Tips

- For some titles, selection can be made using the menu. In this case press the while the indicator is displayed, display the menu screen and make your selection.

Note

- ◆ You cannot switch languages if there is only one language recorded on the disc.
- ◆ Switching the audio language may not be possible with some titles. In this case, the mark will be displayed.
- ◆ Language number and setting differ with each disc, so refer to the disc's instructions.

2. Press to select the desired language.

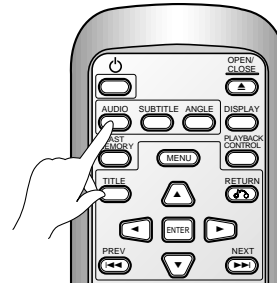
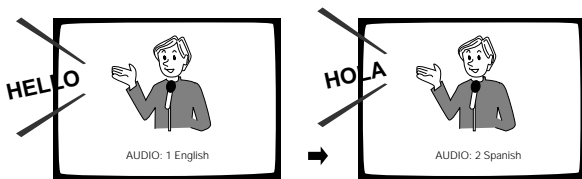

Changing Audio Type

This function can only be used when in the NORMAL MODE.

1. Press during playback.

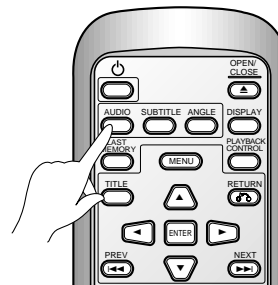
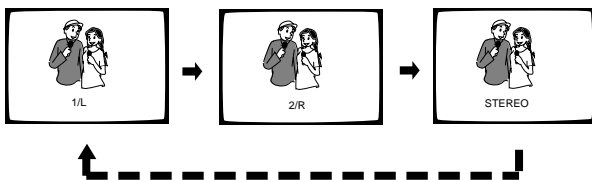

- Audio type changes each time you press the button.

Basic Operation

Detailed Operation

Karaoke Operation

Setting

Set-Up

Other Information

Selecting a Subtitle Language (Multi-Language Subtitles)

You can select a desired subtitle language with DVDs that have subtitle data in multiple languages recorded on them.

1. Press during playback.

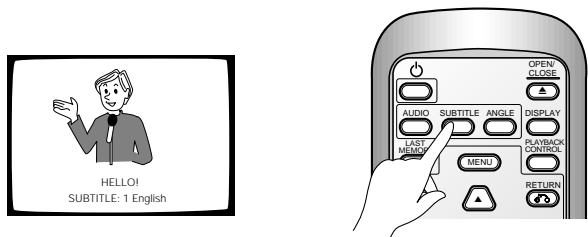

2. Press to select the desired language.



Note

- ◆ The subtitle language can not be switched if the subtitle language is not recorded, or if only one language is recorded.
- ◆ Switching the subtitle language may not be possible with some titles. In this case, the mark will be displayed.

Tips

- To clear subtitles during playback, press after first pressing . You can also clear subtitles by selecting OFF in the subtitle menu display.
- Subtitles can be cleared by selecting LAN. SETUP from the INITIAL menu, and setting SUBTITLE to "OFF" (refer to page 53).
- For some titles, selection can be made using the menu. In this case press the while the indicator is displayed, display the menu screen and make your selection.

Viewing from a Desired Camera Angle (Multi-Angle)

With DVDs featuring recordings of images shot from different angles, you can choose a desired viewing angle.

1. Press during playback.

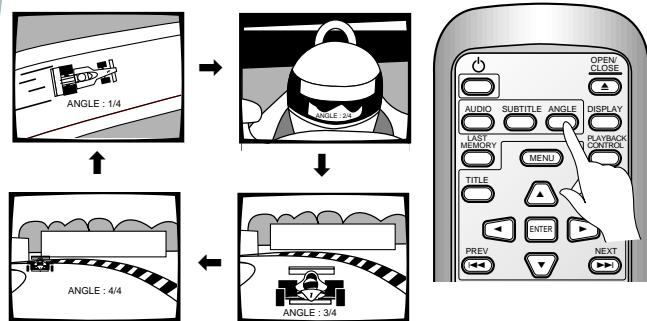

- The camera angle changes each time you press the button.

To check whether or not the disc is recorded with angles:

The jacket of discs that are recorded with angles will be marked with . Also, on this unit, when locations on discs that are recorded with angles are played back, the mark can be displayed.

Angle mark don't display setup

1. Press during the stop mode.
2. Press the number button.
 - The initial set-up menu will appear.
3. Press the number button.
 - The OSD SETUP screen will appear.
4. Press the number button.
 - The ANGLE menu will appear.
5. Press the number button.
 - Menu setup is finished.

Note

- ◆ Some titles may not enable switching between angles. If this happens, the mark is displayed.

Tips

- You can use the Multi-Angle function only with discs featuring recordings of images shot from different camera angles.
- During Multi-Angle playback, the Angle indicator on the player lights.
- For some titles, selection can be made using the menu. In this case press the while the indicator is displayed, display the menu screen and make your selection.

Viewing Disc Information

Press  during playback.

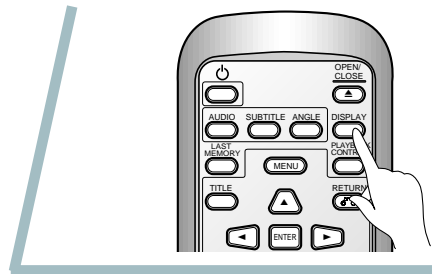

- The display will change as follows each time the button is pressed. Some displays may not be displayed depending on the title.

Press  in the STOP mode.

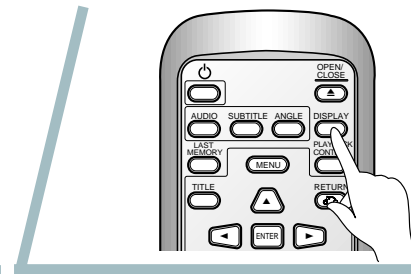

- Disc information is displayed.

Notes

- ◆ To prevent TV screen burn-in, the display automatically switches OFF after about 80 minutes.

With some discs, indications may not be displayed.

DVD

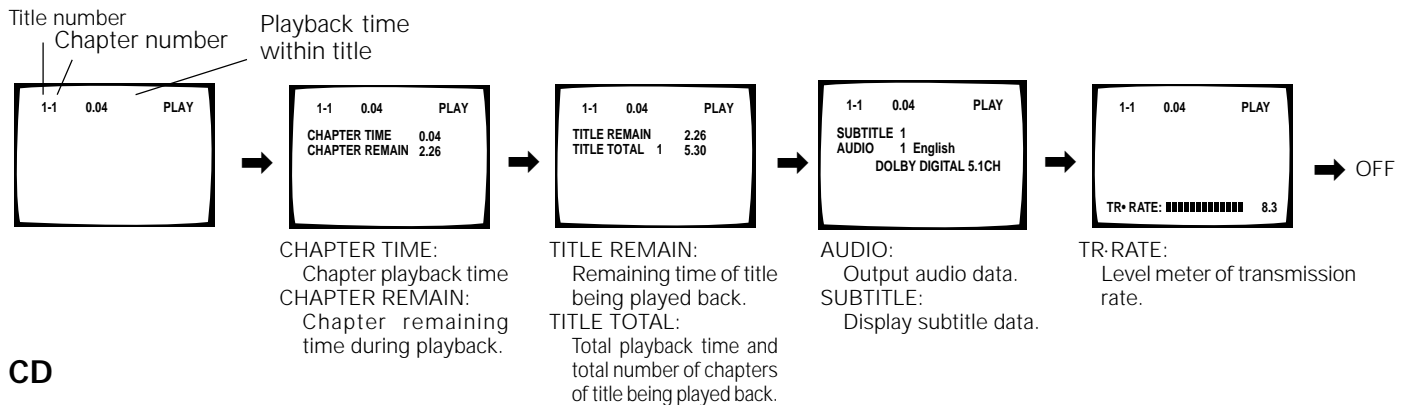

CD

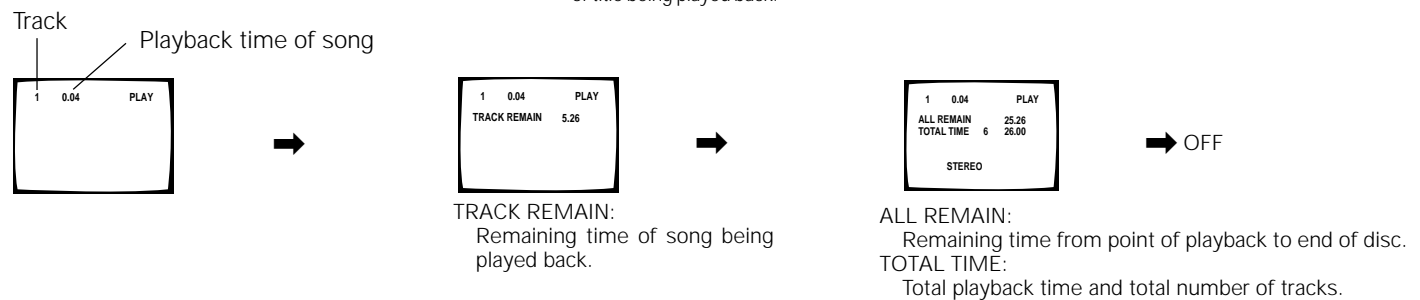

Video CD (PBC OFF)

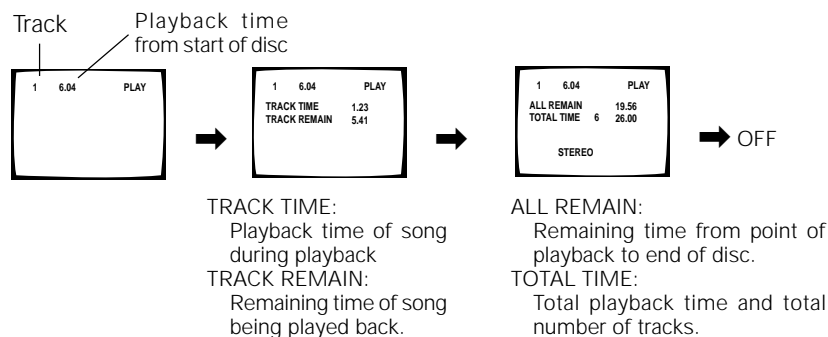

Video CD (PBC ON)

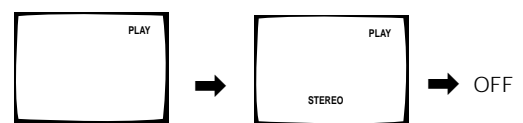

Outline of GUI (Graphical User Interface) Operation

On this player, various settings can be selected while watching menu screens and using the remote control unit. Here we will explain how to access menu screens. Because menu screen access differs according to the type of disc being used, or the playback mode (stop mode etc.), refer to the following menu map when accessing.

DVD

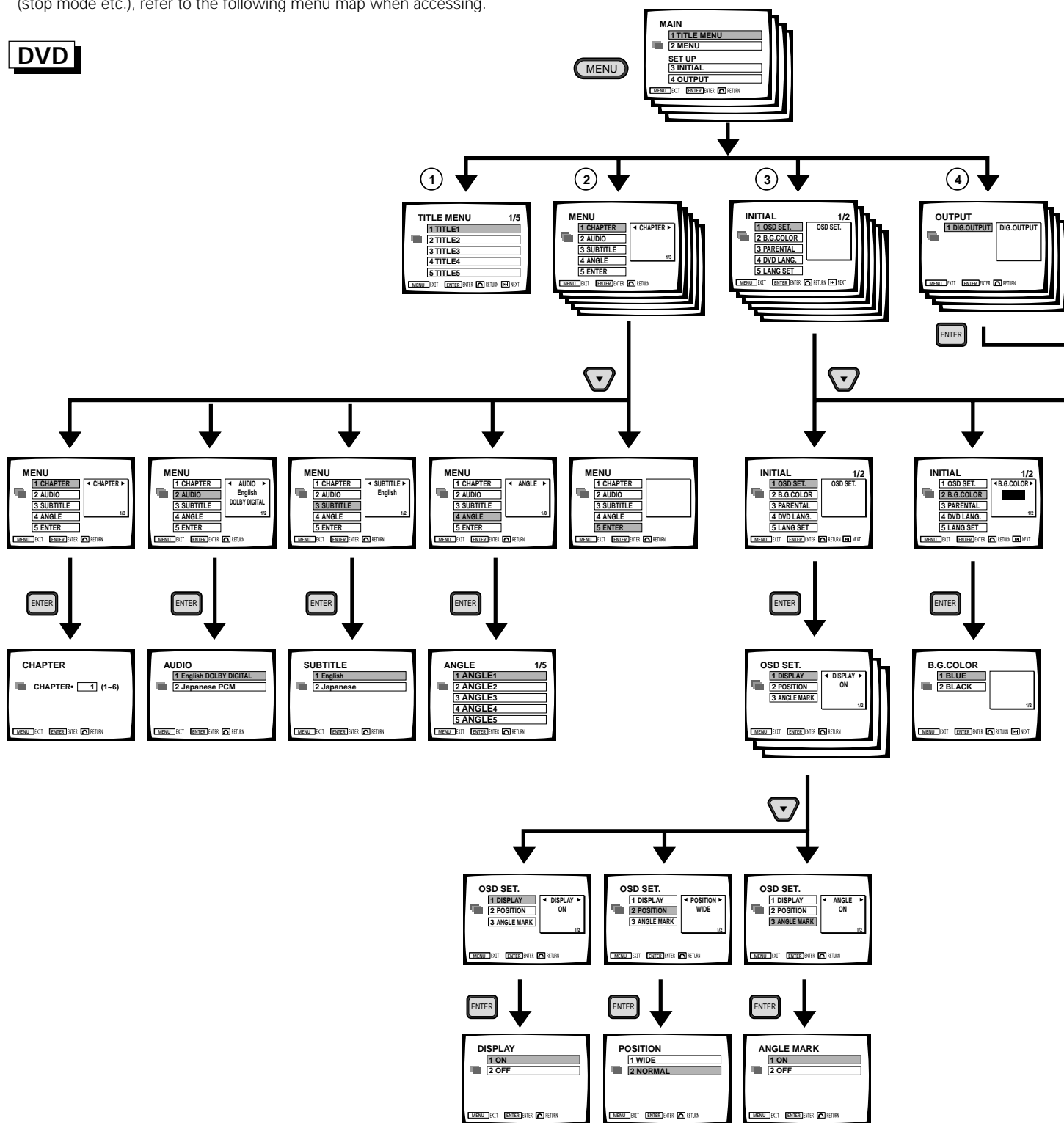

Press the button to return to the screen that was displayed before was pressed.

Outline of GUI (Graphical User Interface) Operation

Basic
Operation

Detailed
Operation

Karaoke
Operation

Setting

Set-Up

Other
Information

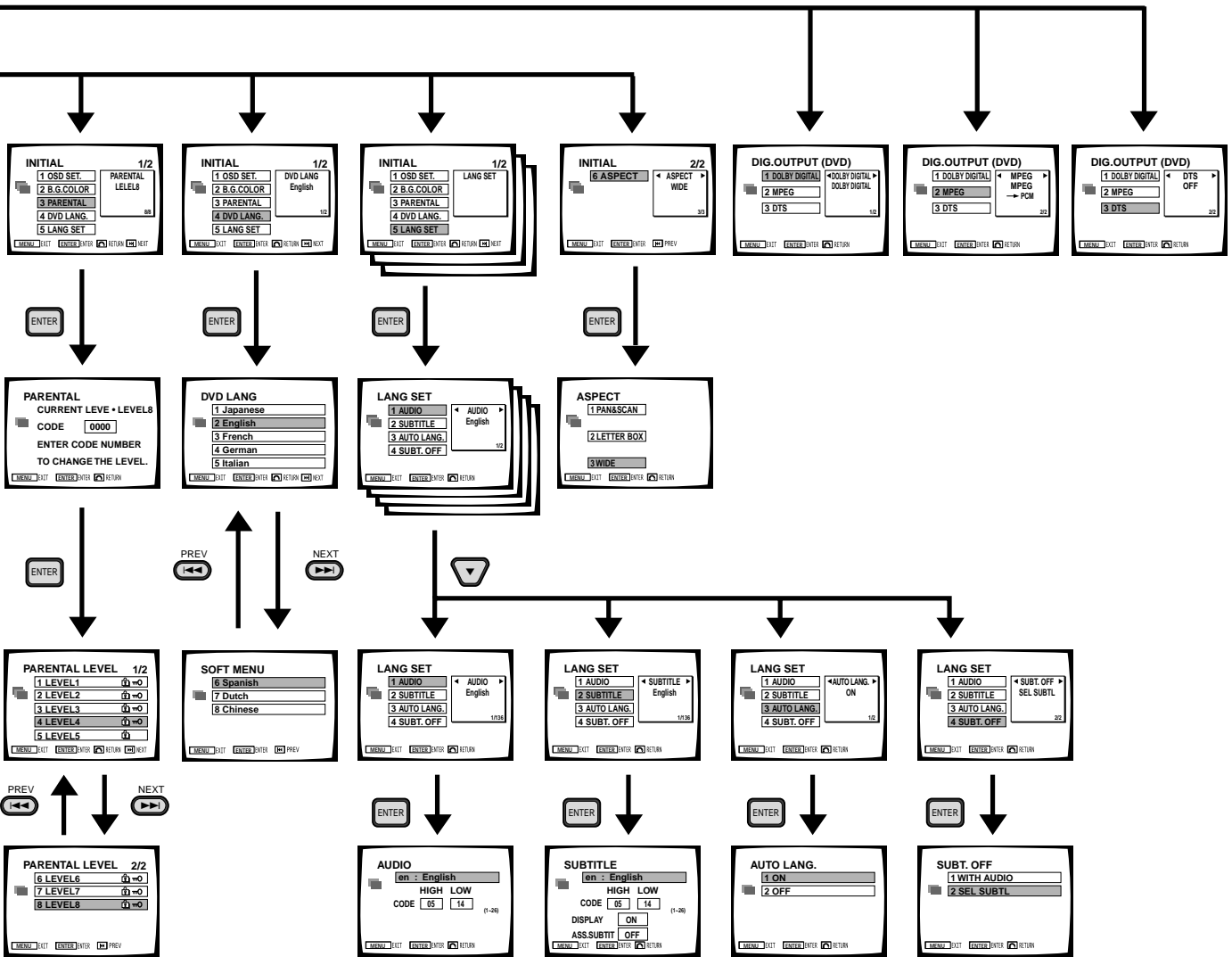





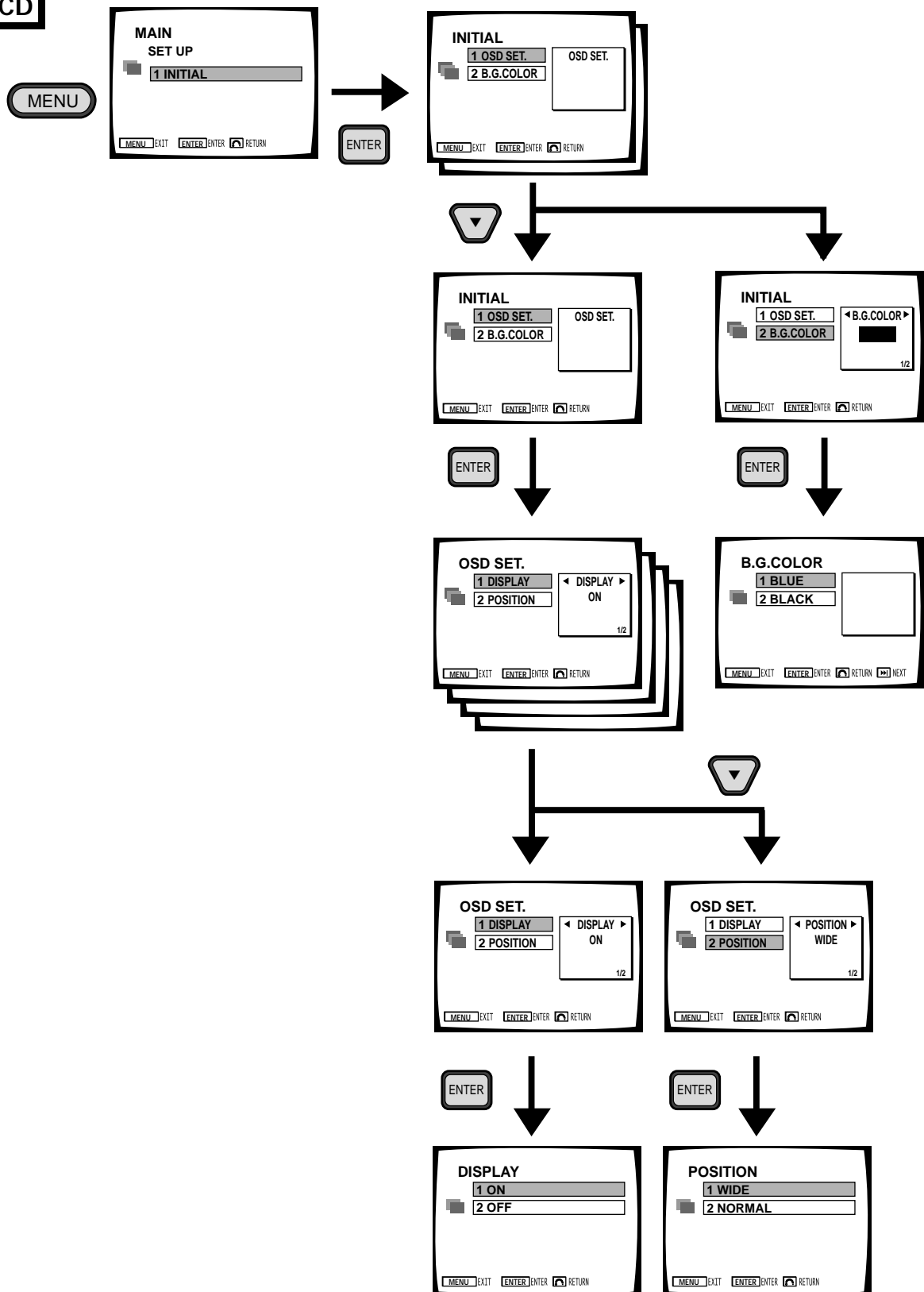

Outline of GUI (Graphical User Interface) Operation

CD, Video CD

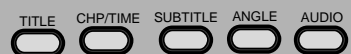

Button operation within each menu

Button name	Button shape	Operation
MENU button		To leave the menu screen (settings are invalidated)
RETURN button		To return one menu screen back (settings will be memorized) However, search is invalidated.
Number buttons		Selection and conclusion (In the set up menu, some items only operate for selection.)
Direction buttons		Selection
ENTER button		Setting and implementation (playback mode is engaged after title or chapter change)
PREVIOUS button		To go to the previous page
NEXT button		To go to the next page
Direct buttons		To go to menus (setting selected before moving to a new menu will be invalidated)

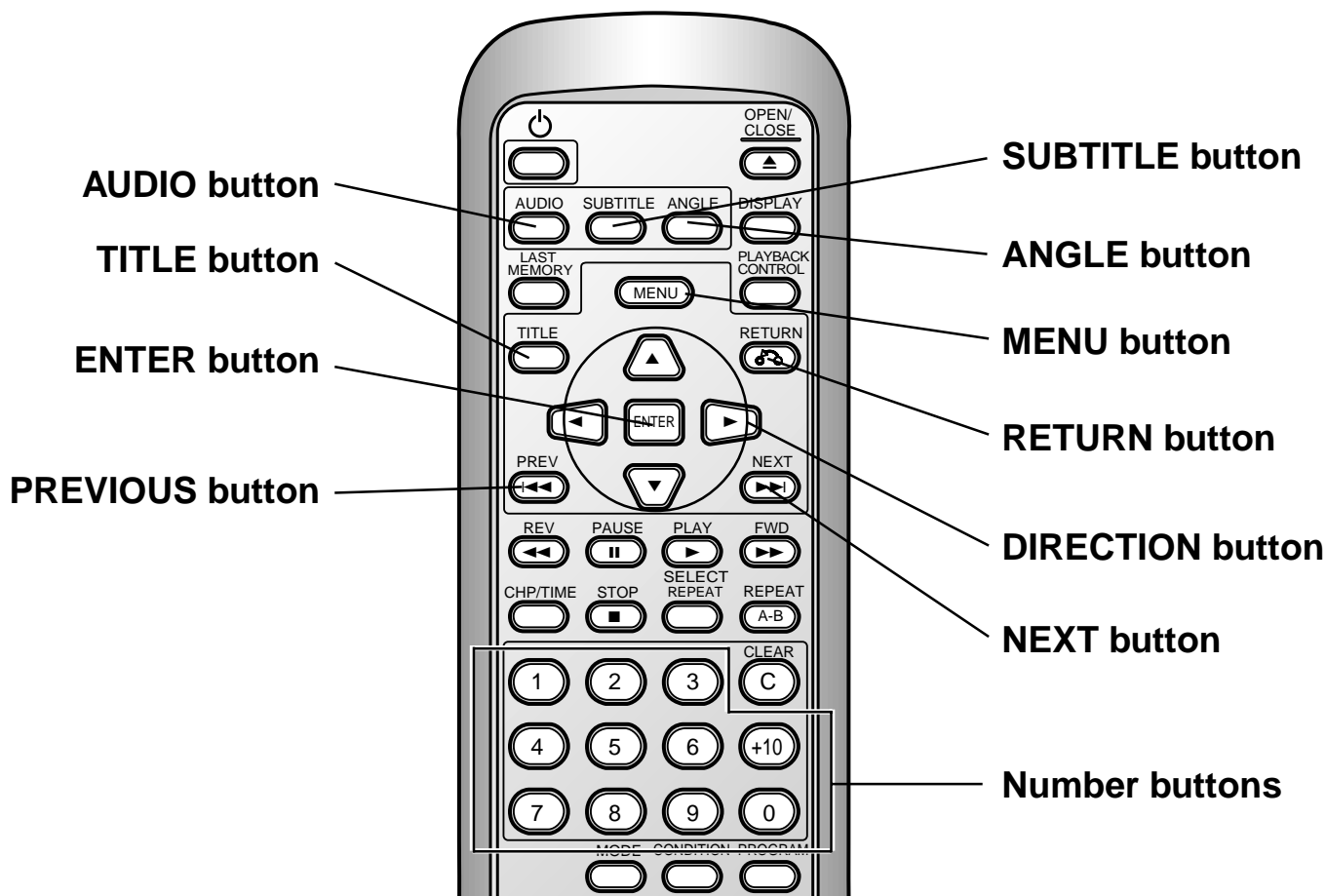

Example of screen displays and operation

Ex. 1: Display contents and button functions within the Menu screen (Example: DVD)

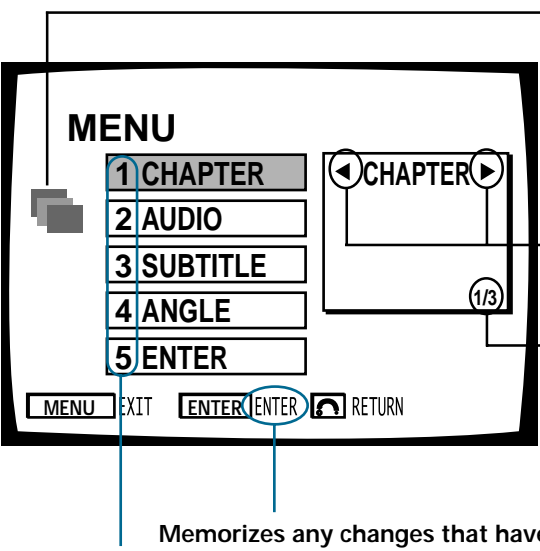

In the top class, the top left of the two squares will be a "blue square".
 In the middle class, the middle of the three squares will be a "blue square".
 In the bottom class, the bottom right of the two squares will be a "blue square".

When the ◀ and ▶ marks are displayed, settings can be changed with the ◀ and ▶ buttons.

Denominator: Total number
 Numerator: Number currently selected.

Memorizes any changes that have been made to the above settings.

Item numbers

Selecting an item number by pressing the **number buttons** or using the ▲ ▼ buttons and then pressing the **ENTER button** will display the menu screen for that item number. Selecting item "5 ENTER" however, will memorize the changed settings and quit the mode.

Ex. 2: Display contents and button functions within the Set-up menu screen (Example: DVD)

Current set-up condition

Item numbers are selected with the ◀ ▶ buttons, and settings are changed with the ▲ ▼ buttons.

Current set-up condition

When selection is made with the number buttons or the ▲ ▼ buttons, pressing the ENTER button will display the selection screen selected.

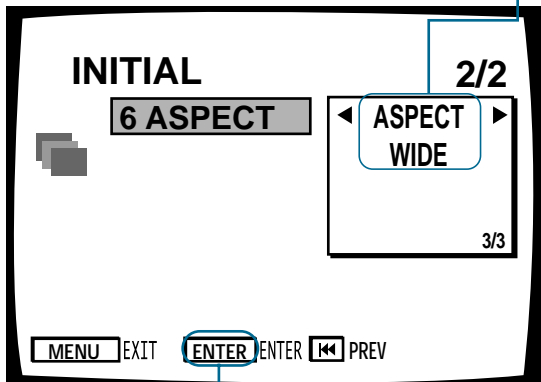
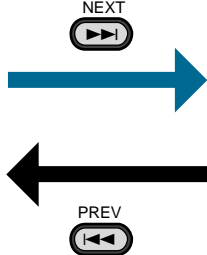
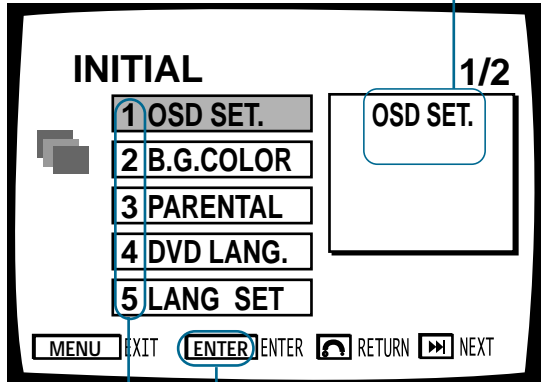

Selecting this will memorize changed settings and quit the mode.

Selection item numbers

Selection can be made with the number buttons. Selecting "B.G. COLOR" , "PARENTAL" , "DVD LANG." or "LANG SET" will display the selected screen.
 Also, changing the settings with the ▲ ▼ buttons and pressing the **ENTER button** will memorize the settings and quit the mode.

About the main menu

The main menu is the menu used for selecting the Title menu screen, Menu screen and Set up screen.

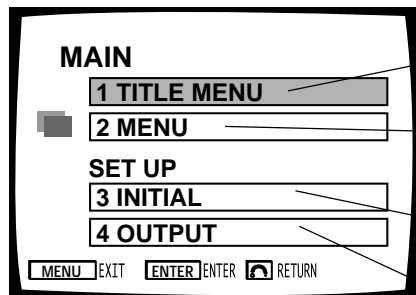

In the Title menu screen:
Titles can be selected and played back. (Title search)

In the Menu screen:
Chapters (songs), subtitles, audio and angles within a title can be selected.

In the Initial setup screen:
The various functions of this player can be set up using the screen displays.

In the Output setup screen:
Audio to be output from the digital output terminal can be selected. Perform setting after switching to NORMAL MODE.

About the title menu

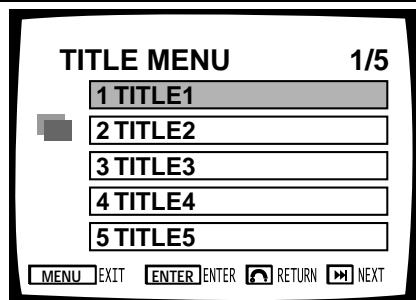

Titles can be selected and played back. This selection screen is the same as the one in "Search with Menu" on page 20.

Menu screen contents

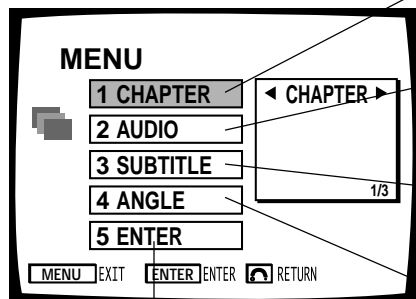

Completes the setting of changes to the above items.

To go to the Chapter screen

In the Chapter screen:
One chapter (song) within a title can be selected and played back.

To go to the Audio screen

In the Audio screen:
Audio contents can be selected on discs that include more than one audio language or audio type.

To go to the Subtitle screen

In the Subtitle screen:
Subtitle contents can be selected on discs that include subtitle information.

To go to the Angle screen

In the Angle screen:
The scene angle that you want can be selected on discs that include scenes that have been filmed from various angles.

Changing Settings

About the initial setup screen

(EX:DVD)

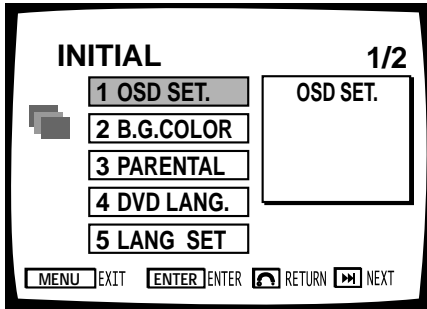

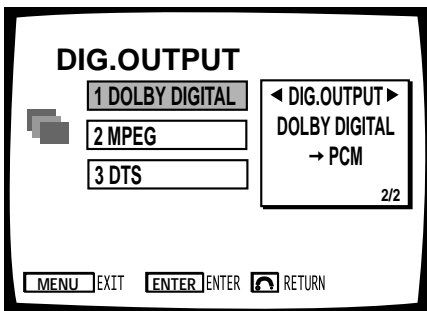

Used when changing various settings. The items and setting details are listed on the next page 53 - 54.

About the output setup screen



Used when selecting the audio to be output from the output terminal.
Set according to the amplifier being used.
Items and setting details are listed in detail on the next page 53 - 54.

Item Settings

Class		Item	Details	Settings	
				Initial settings (factory settings at the time of shipment)	
INITIAL	OSD. SET	DISPLAY	Operation displays (play, stop etc.) can be displayed or not displayed by selecting ON or OFF.	ON Operation displays appear.	OFF Operation displays do not appear.
		POSITION	When watching conventional software on a wide screen TV, the operation display is right at the top of the screen, and you may not be able to see it at all. Changing the position of the display lets you see operation indications clearly even on a wide TV screen.	Normal When using a conventional (4:3) TV	Wide When using a wide screen TV (Not for menu displays.)
		ANGLE MARK	When a picture that is recorded in different angles is played back,  will be displayed. This setting lets you see clearly whether the playback picture is recorded with angles or not.	ON  is displayed.	OFF Not displayed.
		B.G. COLOR	You can select from blue or black background colors for menu displays and the display when playback has stopped. (Initial color is blue)	BLUE	BLACK
		PARENTAL	This lets you control what your children watch by blocking out undesirable material. This player lets you use Parental Lock if the disc has a parental code recorded on it. With Parental Lock capable discs, you can skip material you feel is inappropriate for your children. For details, refer to the instructions that come with the disc. Once you have input a secret 4-digit number, the viewing level (user restriction level) cannot be changed unless the same four numbers are input. Be sure not to forget your secret number. If you do forget it, return to the initial settings and input the secret number once more.	LEVEL 8	Level 1-8 Variable
		DVD LANG.	This lets you select the desired menu language when playing discs that feature menus in different languages.	English	Select the desired menu language.
LANG SET		AUDIO	The audio language that you normally listen to can be selected from the various audio languages on a disc. Even when the audio language is changed during playback, the language selected at this setting will be selected when the disc is replaced.	English	Select from 136 different languages. Selection method is explained on page 55.
		SUBTITLE	The subtitle language that you will normally display can be selected from the subtitles on a disc. Even when the subtitle language is changed during playback, the language selected at this setting will be selected when the disc is replaced.	English	Select from 136 different languages. Selection method is explained on page 55.

Basic
Operation

Detailed
Operation

Karaoke
Operation

Setting



Set-Up

Other
Information

Item Settings

Class		Item	Details	Settings	
				Initial settings (factory settings at the time of shipment)	
INITIAL	LANG SET	AUTO LANG.	AUDIO and SUBTITLE can be set in advance. In the case of foreign movies, the original audio language and English subtitles will be automatically selected. In the case of English language movies, the original audio language (English) will be selected, and subtitles will not be displayed. On some discs, this function may not operate as described in the example. If AUDIO and SUBTITLE differ or DISPLAY and ASS.SUBTIT of the SUBTITLE sets OFF, the setting will be the same as OFF., changing settings during playback using "Selecting Languages" (page 43) and "Selecting Subtitle Language" (page 44) is possible. OFF Regular subtitle and audio settings will be as selected.	ON	OFF
		SUBT.OFF	The subtitle which is displayed by discs can be selected, when the subtitle is set to "OFF". SEL SUBTL: The selected subtitle language will be selected. WITH AUDIO: The selected audio language will be selected.	SEL SUBTL	WITH AUDIO
	ASPECT	When viewing software recorded in the wide mode, the image's height to width ratio can be switched to match the TV being used.	WIDE	PAN&SCAN LETTER BOX	
OUTPUT	DIG. OUTPUT	DOLBY DIGITAL	This player lets you change the audio output via an optical digital output jack and coaxial digital output jack. Selection of a DVD's Dolby Digital audio (3 dimensional audio used in theaters etc.) or Linear PCM (same digital audio as that on CD) can be made.	DOLBY DIGITAL The Dolby digital signal is output as is. (When an amplifier with built-in Dolby digital (AC-3) decoder is used.)	DOLBY DIGITAL → PCM Provides Linear PCM sound with both Dolby Digital and Linear PCM sources (when a regular amp or Dolby Pro logic amp is used).
		MPEG	When a decoder or amplifier that has an MPEG input jack is used, the audio output from this unit's optical digital output jack and digital output's (coaxial) can be changed. Selection of a DVD's MPEG or linear PCM signal can be made.	MPEG → PCM Output is in the linear PCM standard whether the signal is an MPEG signal or a linear PCM compatible signal.	MPEG The MPEG signal is output as is.
		DTS	When using an amplifier that has a DTS input jack, the DTS signal can be set to be output (ON) or not output (OFF) for DVDs that have been recorded with DTS signals.	OFF	ON

Returning changed settings to the initial settings (initialization)...

First make sure the power is turned off. With the power off, while pressing the  button, press the  button.

How to Set Basic Audio and Subtitles

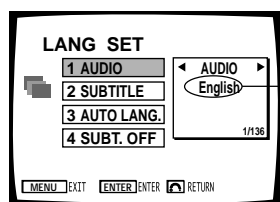

Changes in order when the remote control's or button is pressed.

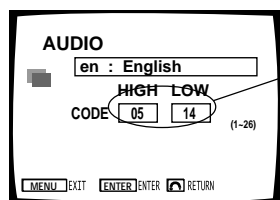
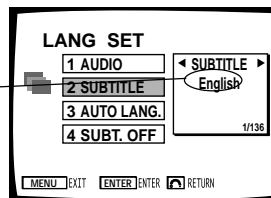

Referring to the input codes (high order, low order) on the following language code list, use the remote control's number buttons (For selection of numbers above 10, use the +10 button) to select the number that corresponds to the language that you want to select.

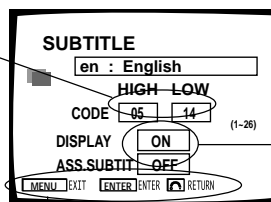

After selecting this display with the remote control's or button, display ON and display OFF can be selected with the remote control's or button.

- When the auto setting is ON (page 54), because auto setting is given priority, the English audio and subtitles may differ from the language set for the basic audio and basic subtitles.

Some discs provide subtitles offering explanations of scenes for the hard of hearing. Switching "ASS.SUBTIT" ON assures these subtitles are displayed from the beginning.

Language code list

Language	Language-code	Input-code (high-order)	Input-code (low-order)
Japanese	ja	10	01
English	en	05	14
French	fr	06	18
German	de	04	05
Italian	it	09	20
Spanish	es	05	19
Dutch	nl	14	12
Russian	ru	18	21
Chinese	zh	26	08
Korean	ko	11	15
Greek	el	05	12
Afar	aa	01	01
Abkhazian	ab	01	02
Afrikaans	af	01	06
Amharic	am	01	13
Arabic	ar	01	18
Assamese	as	01	19
Aymara	ay	01	25
Azerbaijani	az	01	26
Bashkir	ba	02	01
Belorussian	be	02	05
Bulgarian	bg	02	07
Bihari	bh	02	08
Bislama	bi	02	09
Bengali, Bangla	bn	02	14
Tibetan	bo	02	15

Language	Language-code	Input-code (high-order)	Input-code (low-order)
Breton	br	02	18
Catalan	ca	03	01
Corsican	co	03	15
Czech	cs	03	19
Welsh	cy	03	25
Danish	da	04	01
Bhutani	dz	04	26
Esperanto	eo	05	15
Estonian	et	05	20
Basque	eu	05	21
Persian	fa	06	01
Finnish	fi	06	09
Fiji	fj	06	10
Faroese	fo	06	15
Frisian	fy	06	25
Irish	ga	07	01
Scottish Gaelic	gd	07	04
Galician	gl	07	12
Guarani	gn	07	14
Gujarati	gu	07	21
Hausa	ha	08	01
Hindi	hi	08	09
Croatian	hr	08	18
Hungarian	hu	08	21
Armenian	hy	08	25
Interlingua	ia	09	01

How to Set Basic Audio and Subtitles

Language	Language-code	Input-code (high-order)	Input-code (low-order)
Interlingue	ie	09	05
Inupiak	ik	09	11
Indonesian	in	09	14
Icelandic	is	09	19
Hebrew	iw	09	23
Yiddish	ji	10	09
Javanese	jv	10	23
Georgian	ka	11	01
Kazakh	kk	11	11
Greenlandic	kl	11	12
Cambodian	km	11	13
Kannada	kn	11	14
Kashmiri	ks	11	19
Kurdish	ku	11	21
Kirghiz	ky	11	25
Latin	la	12	01
Lingala	ln	12	14
Laothian	lo	12	05
Lithuanian	lt	12	20
Latvian, Lettish	lv	12	22
Malagasy	mg	13	07
Maori	mi	13	09
Macedonian	mk	13	11
Malayalam	ml	13	12
Mongolian	mn	13	14
Moldavian	mo	13	15
Marathi	mr	13	18
Malay	ms	13	19
Maltese	mt	13	20
Burmese	my	13	25
Nauru	na	14	01
Nepali	ne	14	05
Norwegian	no	14	15
Occitan	oc	15	03
(Afan) Oromo	om	15	13
Oriya	or	15	18
Panjabi	pa	16	01
Polish	pl	16	12
Pashto, Pushto	ps	16	19
Portuguese	pt	16	20
Quechua	qu	17	21
Rhaeto-Romance	rm	18	13
Kirundi	rn	18	14

Language	Language-code	Input-code (high-order)	Input-code (low-order)
Rumanian	ro	18	15
Kinyarwanda	rw	18	23
Sanskrit	sa	19	01
Sindhi	sd	19	04
Sango	sg	19	07
Serbo-Croatian	sh	19	08
Singhalese	si	19	09
Slovak	sk	19	11
Slovenian	sl	19	12
Samoaan	sm	19	13
Shona	sn	19	14
Somali	so	19	15
Albanian	sq	19	17
Serbian	sr	19	18
Siswati	ss	19	19
Sesotho	st	19	20
Sundanese	su	19	21
Swedish	sv	19	22
Swahili	sw	19	23
Tamil	ta	20	01
Telugu	te	20	05
Tajik	tg	20	07
Thai	th	20	08
Tigrinya	ti	20	09
Turkmen	tk	20	11
Tagalog	tl	20	12
Setswana	tn	20	14
Tonga	to	20	15
Turkish	tr	20	18
Tsonga	ts	20	19
Tatar	tt	20	20
Twi	tw	20	23
Ukrainian	uk	21	11
Urdu	ur	21	18
Uzbek	uz	21	26
Vietnamese	vi	22	09
Volapük	vo	22	15
Wolof	wo	23	15
Xhosa	xh	24	08
Yoruba	yo	25	15
Zulu	zu	26	21

Set-Up

Connecting the Player

Connection example 1. To a TV with Video input	58
Connection example 2. AV receiver with digital input for Dolby Digital (AC-3)	59
Connection example 3. AV amplifier	60

Names and Functions

Remote control	61
Front panel	62
Rear panel	62
Display window	63

Other Information

Troubleshooting	64
For Proper and Long Use	66
Terms	68
Specifications	69

Connecting the Player

Precautions when connecting the player

This player's Analog copy protect technology is copy guarded. If you connect the player to a TV via a VCR, or record and playback the contents of a disc with a VCR, the playback picture may not be normal.

Connect the DVD player either directly to the television or through an A/V amplifier.

Before making or changing the connections, switch off the power switch and disconnect the power cord from the AC outlet.

Select one of the following ways to connect the player to your TV.

Connection example 1.

To a TV with video input

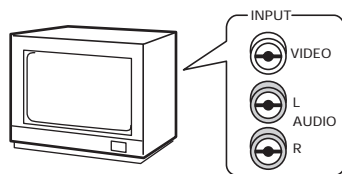

If your TV has a video input, and it is available for use, this is the easiest way to hook up the player.

Follow the instructions in the TV's (monitor TV's) User's Manual.

Video out



Audio out

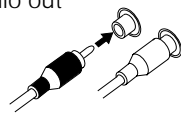

- Connect plugs to the terminals that match the plug's color (white, red, yellow).

S-Video out

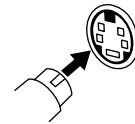

- Connect the TV with S-VIDEO terminal to the S VIDEO OUT terminal of this player.

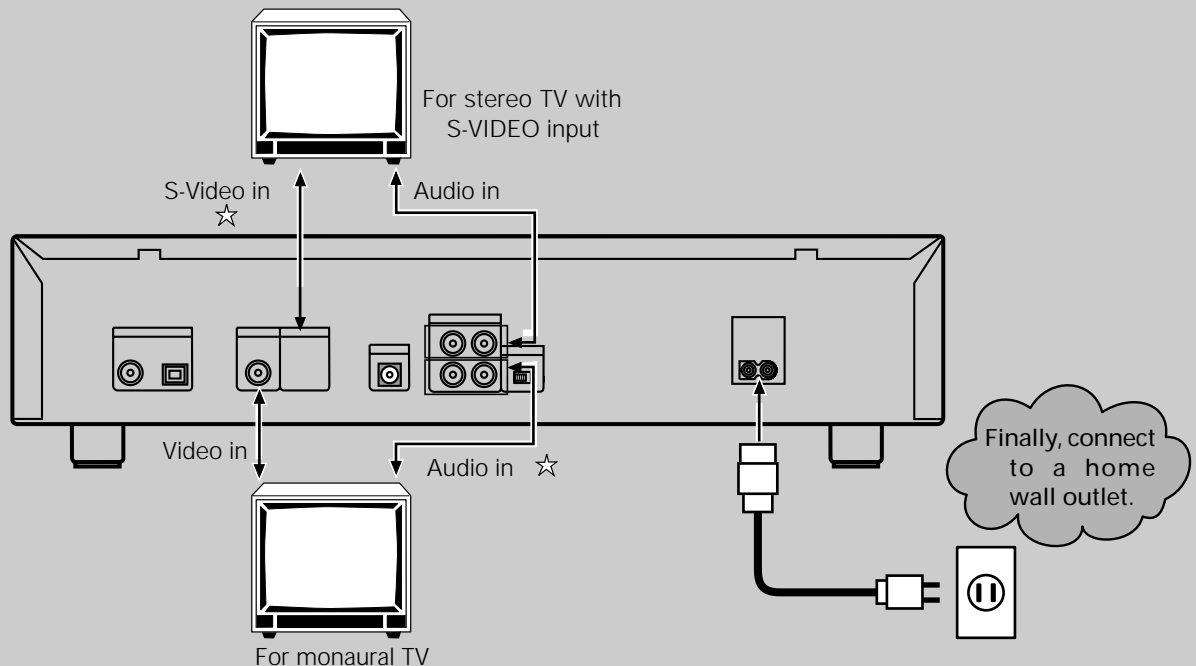

- Please also refer to the manual for the TV (monitor TV or VCR) that you are making connection to.

Note

☆ Cables can be found at your local audio/video dealer.

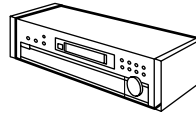
Connection example 2.**AV receiver with digital input for Dolby Digital (AC-3).**

When connecting the player to an amplifier with Dolby Digital (AC-3) inputs.

*Make this connection when using this unit with Pioneer's VSX-07TX, VSX-09TX AV receiver.

- Connect this unit's DIGITAL OUT jack to the Dolby Digital (AC-3) input jack of a Dolby Digital compatible amplifier.
- Select whether or not to use the coaxial digital output according to the amplifier's input jack.

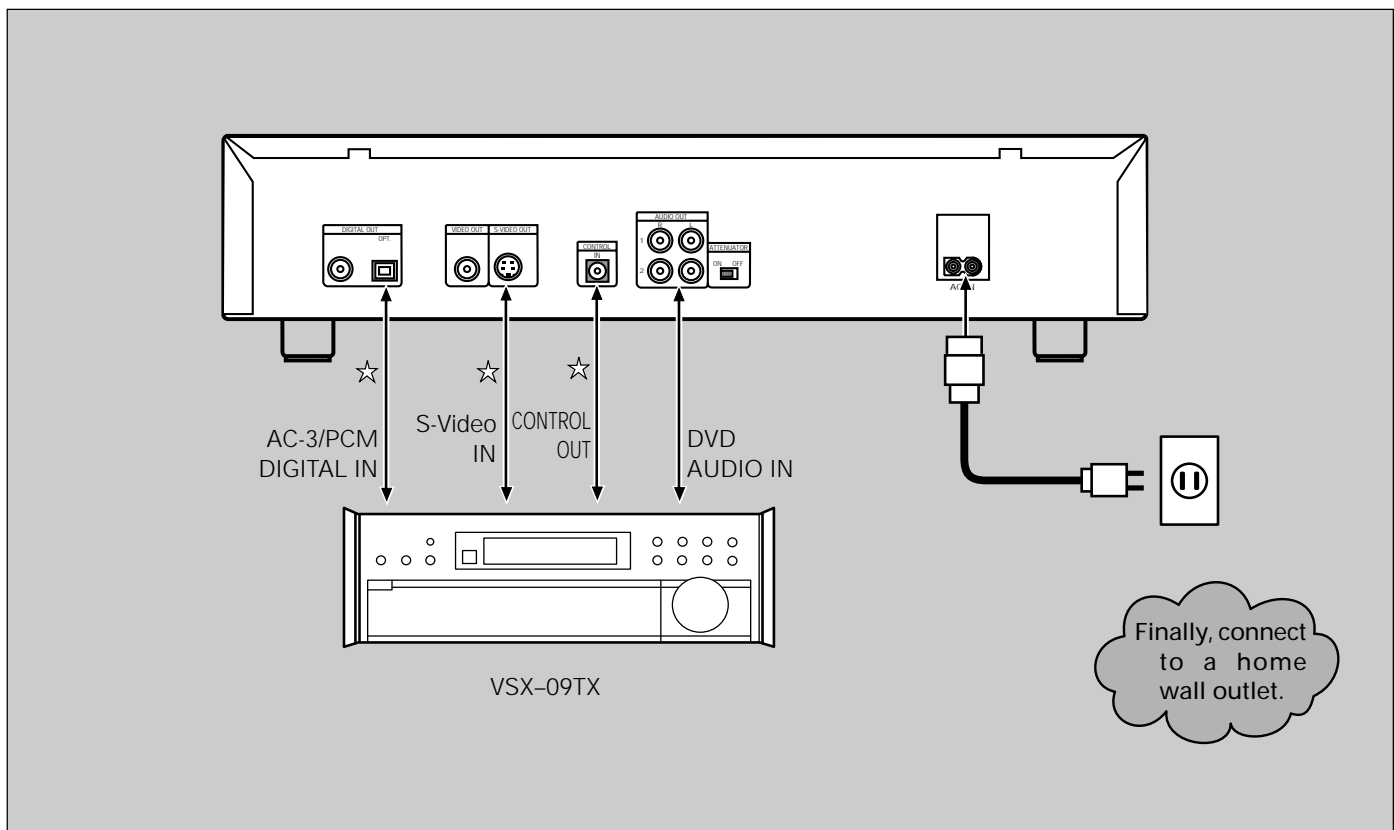

- Digital signal is not output in KARAOKE MODE.

When using for karaoke

- Be sure to connect the player's AUDIO OUT to the amplifier's DVD AUDIO IN.

Note

- ☆ Cables can be found at your local audio/video dealer.

Please set the amplifier's function as follows when playing back a disc on this unit.
 DVD playback: DVD
 Other discs that can be played back such as a CD etc.: CD

Connection example 3.

AV amplifier

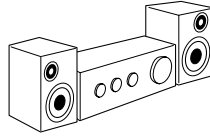

By connecting to a regular AV amplifier or stereo amp, you can enjoy playback with improved sound quality.

- Connect this player's audio output jacks to an amplifier's CD, LD, AUX or other audio input jacks. (Do not connect to PHONO jacks.)
- Connect this player's video output jack to the amplifier's video input jack.

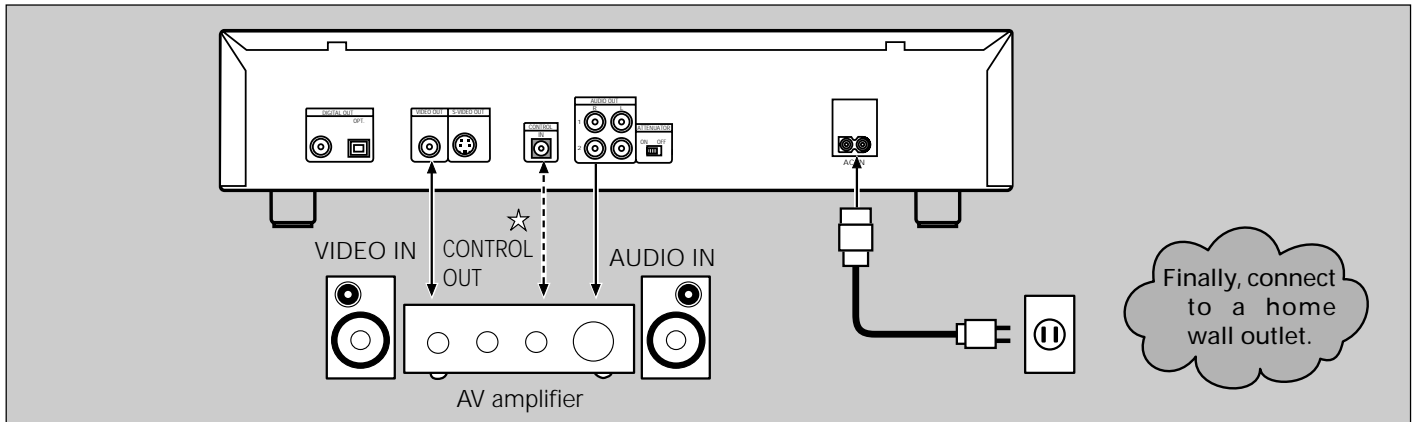

Note

☆ Cables can be found at your local audio/video dealer.

- **When connecting to a component bearing the Pioneer SR mark:**
If you use a commercially available cord with a mini plug (no resistance) to connect this player's CONTROL IN jack to the control output jack of another component bearing the SR mark, you can control the player as though it were a component in a system (system control).
If you connect for system control, you cannot operate the player directly by pointing the remote control at it and pressing buttons.
When controlling as a system, be sure to make connection to the amplifier using an audio cord, even when using only digital components.
For more details, refer to the connected component's operation manual.
- Surround sound can be enjoyed with amplifiers that have a built-in Dolby Pro Logic decoder.

Names and Functions

Remote control

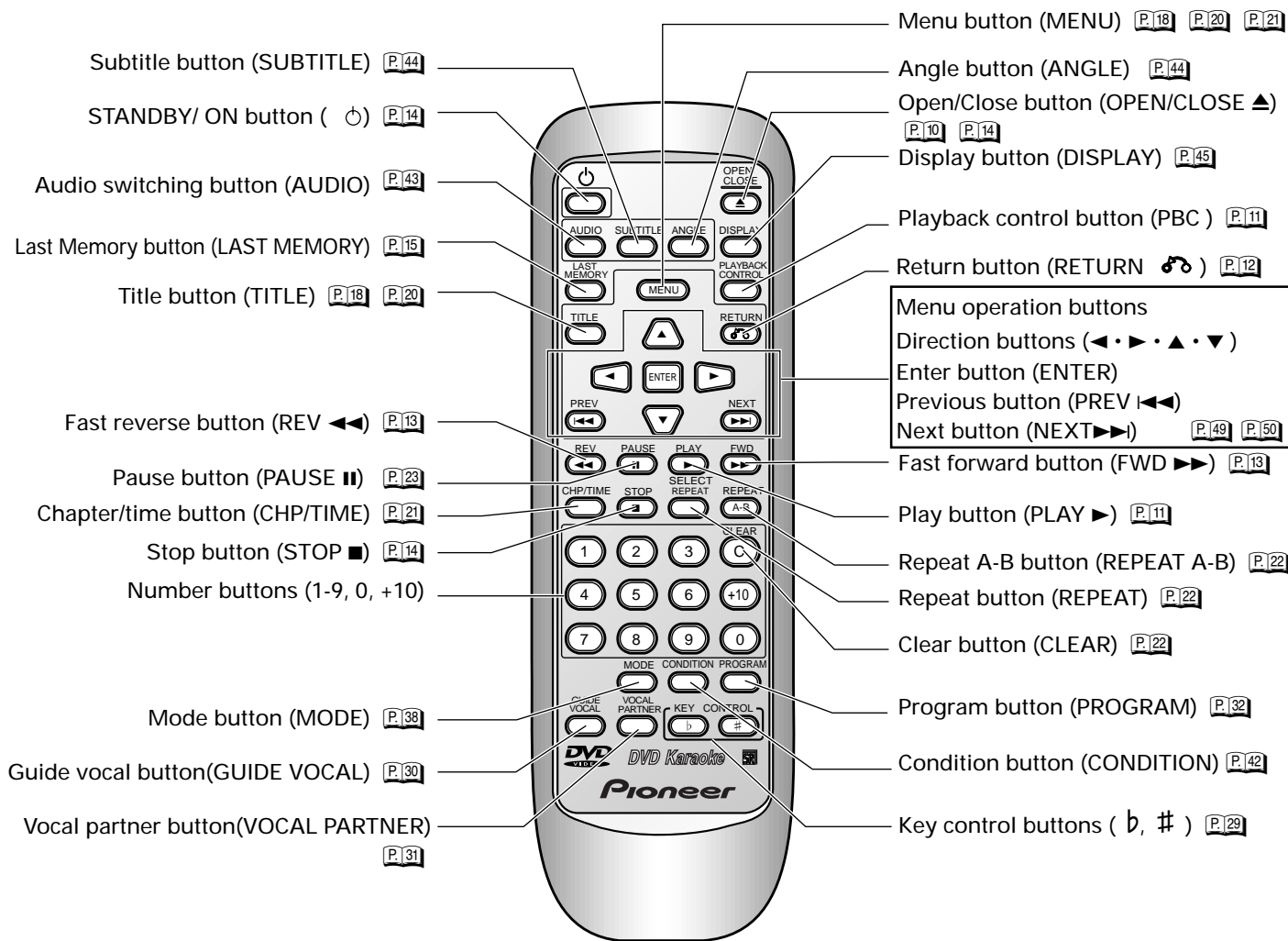

Remote control operation

When operating the remote control, point it at the remote sensor located on the player's front panel. The remote control can be used up to 23 feet (7 m) from the player and within a 30° angle each side of the sensor.

- Exposing the remote sensor to direct sunlight or strong light may cause faulty operation.
- If the CONTROL IN jack on the player's rear panel is connected to another component, point the remote control at that component for operation. Operation is not possible when pointed at this player (page 60).

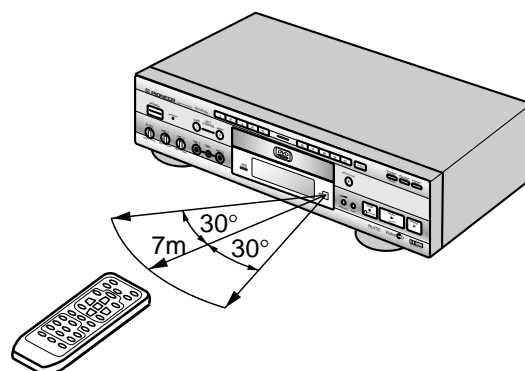

Basic Operation

Detailed Operation

Karaoke Operation

Setting

Set-Up

Other Information

Front panel

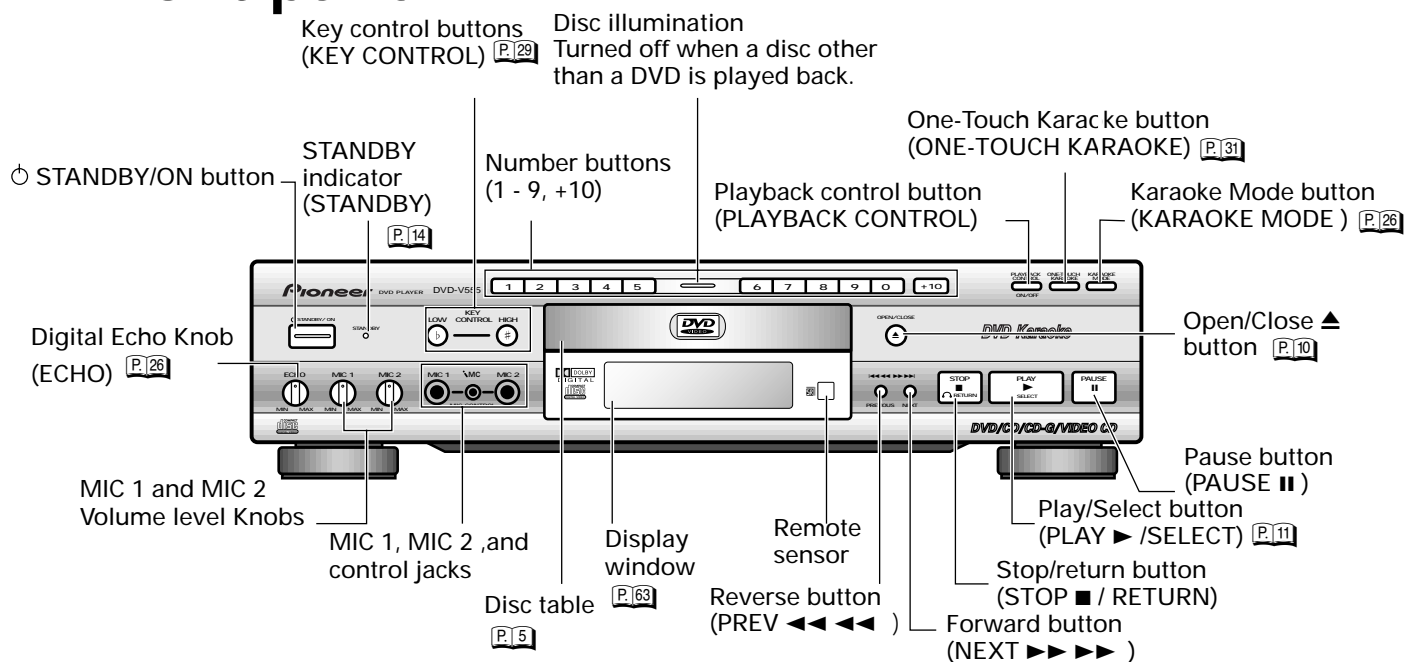

Rear panel

Digital Output Jack

This is used for output of the digital audio signal recorded on DVDs, CDs and Video CDs. Depending on the components connect this digital output to, noise may be generated.

Your amplifier	Regular AV amplifier	Coaxial	Connect to the coaxial jack, and select DOLBY DIGITAL → PCM from the menu.
		Optical	Connect to the optical jack, and select DOLBY DIGITAL → PCM from the menu.
	Dolby Digital (AC-3) compatible amplifier	Coaxial	Connect to the coaxial jack, and select DOLBY DIGITAL from the menu.
		Optical	Connect to the optical jack, and select DOLBY DIGITAL from the menu.

Optical Digital Output

This is used for connection to an amplifier with a optical digital input terminal.

Digital Output(Coaxial)

This is used for connection to an amplifier with a coaxial digital input terminal.

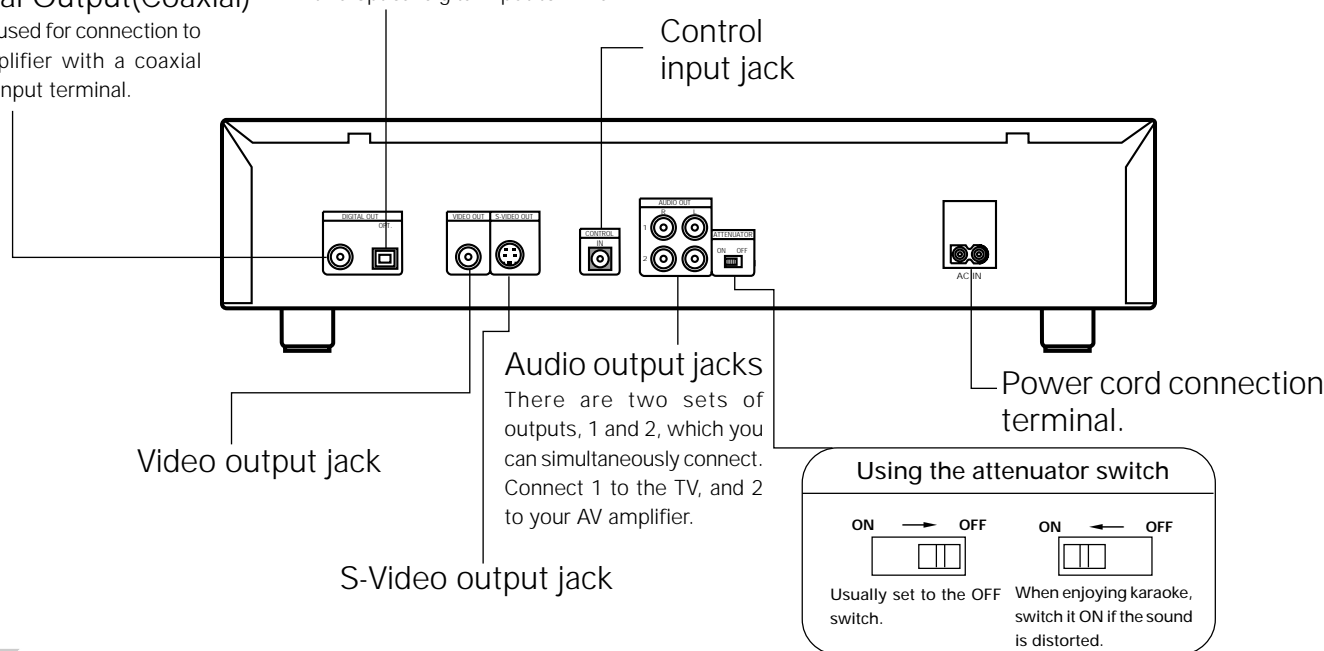

Display window

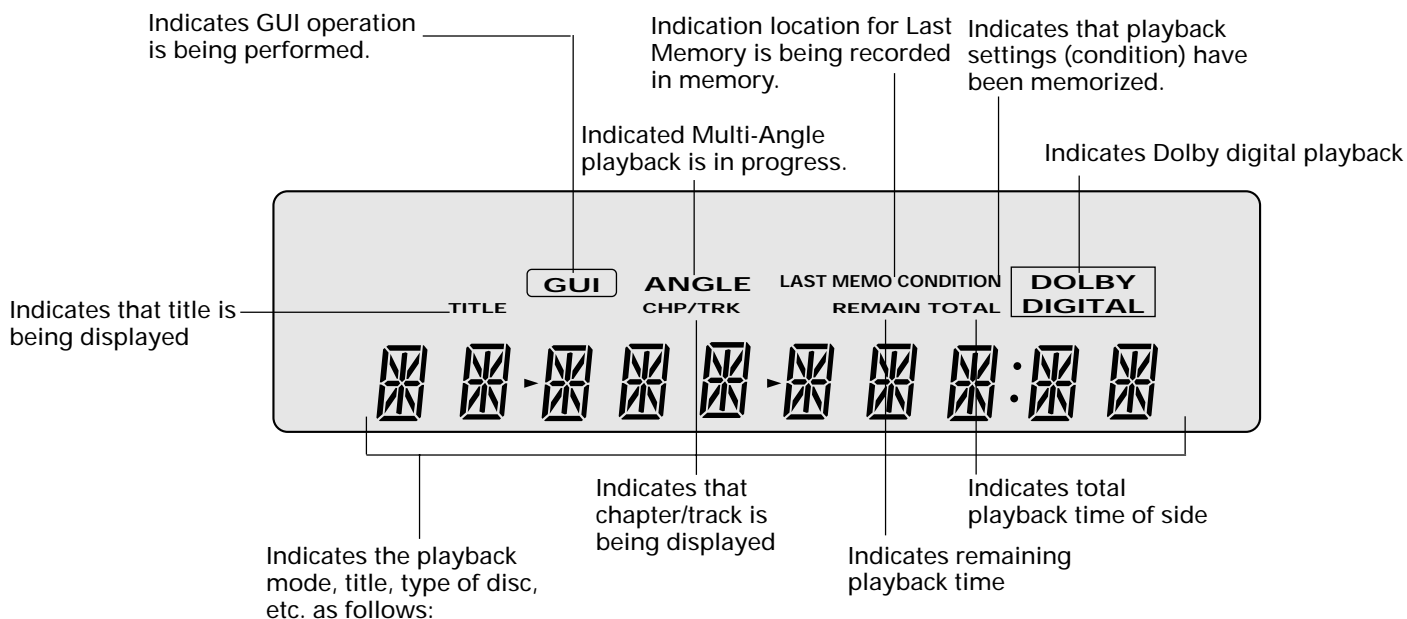



Sample Display

CD	:Compact disc	REPEAT TTL	:When title repeat is selected
DVD	:DVD	PLAY	:Playback
VIDEO CD	:Video CD	STOP	:Stop
PBC PLAY	:Playback control playback on Video CD	PAUSE	:Pause
OPEN	:Disc table is opening or is open	NO DISC	:No disc
CLOSE	:Disc table is closing	-- OFF --	:Power is turned off
PGM	:Program mode	MENU	:Menu mode
R_TRK	:Repeat mode	TITLE	:Title menu
R_A	:Start point of 2 point repeat playback	SETUP	:Set-up menu
R_AB	:2 point repeat playback	COND_MEM	:Condition memory
R_TTL	:Repeat playback of the title	LAST_MEM	:Last memory
R_CHP	:Repeat playback of the chapter	VO_P	:Vocal partner on
R_SID	:Disc repeat	G_VO	:Gvide vocal on
REPEAT A	:When memory repeat is selected		
REPEAT TRK	:When track repeat is selected		
REPEAT CHP	:When chapter repeat is selected		
REPEAT SID	:When side repeat is selected		

Troubleshooting

Incorrect operations are often mistaken for trouble and malfunctions. If you think that there is something wrong with this component, check the points below. Sometimes the trouble may lie in another component. Inspect the other components and electrical appliances being used. If the trouble cannot be rectified even after exercising the checks listed below, ask your nearest PIONEER authorized service center or your dealer to carry out repair work.

	Symptom	Possible causes	Reference page
Operation	1.The disc comes back out even when the disc table is closed.	<ul style="list-style-type: none"> ● The disc is dirty or warped. ● The disc is not placed properly on the disc table. ● Region No. does not conform with this unit. 	p.67 p.10 p.69
	2.Playback is not possible.	<ul style="list-style-type: none"> ● Condensation has formed inside the player. ● This player cannot play PAL and SECAM format DVD discs. 	
	3.Picture disturbance during playback.	<ul style="list-style-type: none"> ● This player is compatible with Macro-Vision System copy guard. Some discs include a copy prevention signal, and when this type of disc is played back, stripes etc., may appear on some sections of the picture depending on the TV. (This is not a malfunction.) 	
	4.When recorded on a VCR there is disturbance in the playback picture.	<ul style="list-style-type: none"> ● This player is compatible with analog copy protect technology copy guard. Some discs include a copy prevention signal and the copy guard system will prevent proper playback. 	
	5.  mark appears on screen.	<ul style="list-style-type: none"> ● The selected function does not operate for that disc. 	
	6.Picture playback stops and the operation button can not be used.	<ul style="list-style-type: none"> ● First stop the disc (press the  button), then start playback again. 	
Remote control	7.Remote control operation is not possible.	<ul style="list-style-type: none"> ● The rear panel CONTROL IN jack on the player is being used. ● The remote control is too far from the player, or the angle with the remote sensor is too sharp. 	p.60 p.8
	8.Improper operation of TV set, etc., occurs.	<ul style="list-style-type: none"> ● The batteries are exhausted. ● Some TVs that have wireless remote control functions may not operate properly with this remote control. 	
Audio	9.Audio is not output or is distorted.	<ul style="list-style-type: none"> ● Digital signal is not output in KARAOKE MODE. ● Digital output is prohibited for some discs. ● The connection plugs are not inserted fully into the terminals or are not connected. ● The connection plug or terminal is dirty. ● Audio cable connection is wrong. ● Connection is made to the stereo amplifier's PHONO input terminal. ● The pause mode is engaged. ● Stereo amplifier operation is wrong. 	
	10. Noticeable difference in DVD and CD volume.	<ul style="list-style-type: none"> ● Although you may notice a difference in volume between CDs and DVDs, this is a the result of a difference in disc recording methods. 	

Symptom	Possible causes	Reference page
Karaoke operations	11.Key control and Once more are not possible with a MIC featuring controls.	● The MIC is not connected to the MIC control jack. P.29
	12.Even when playing a multiplex disc, the singer's voice cannot be heard.	● ONE-TOUCH KARAOKE is ON. P.31
	13.There's howling.	● The MIC is too close to the speakers. P.27
	14."PICK A KARAOKE SONG" is automatically displayed.	● The KARAOKE MODE is ON. P.26
	15.Song reservation is not possible with a Video CD with Playback Control.	● Playback Control is switched OFF. P.32
	16.Karaoke operations aren't possible.	● The selected mode is NORMAL. Press the KARAOKE MODE button on the main unit to select the KARAOKE MODE. P.26
	17.There's no sound from the MIC.	● With an amplifier featuring a digital input, the audio output jack is not connected (with an analog audio cord). P.59 ● With a Dolby Digital compatible amplifier (an amplifier on which the AUTO setting can be selected for SIGNAL SELECT), AUTO is selected.

Caution:

Abnormal functioning of this unit may be caused by static electricity, or other external interference. To restore normal operation, unplug the AC power cord and then plug it in again.

Basic
Operation

Detailed
Operation

Karaoke
Operation

Setting

Set - Up

Other
Information

For Proper and Long Use

■ DO NOT MOVE THE UNIT DURING PLAYBACK

During playback, the disc rotates at high speed. Do NOT lift or move the unit during playback. Doing so may damage the disc.

■ WHEN MOVING THE UNIT

When there is a power outage, the power is turned off during playback, with the STANDBY/ON button on the main unit or you disconnect the player from the wall outlet while the power is ON, settings are cleared. Before disconnecting the power cord, press the STANDBY/ON button on the remote control to enter the unit to standby mode after distinguishing the “- OFF -” display, then press the STANDBY/ON button on the main unit.

■ INSTALLATION

- Select a stable place to the side of a TV set or stereo system to be connected to the unit.
- When using the unit with a stereo system, install the speakers a little bit away from the TV.
- Do NOT install the unit on top of a TV or color monitor. Install the unit away from equipment that may be affected by magnetism, such as a cassette deck.

■ AVOID INSTALLING IN A PLACE THAT IS:

- Exposed to direct sunlight
- Exposed to humidity or where ventilation is poor
- Extremely hot or cold
- Exposed to vibration
- Exposed to dust
- Exposed to oily smoke, steam or heat (for example, a kitchen)

■ DO NOT PLACE AN OBJECT ON TOP

Do NOT place an object on the unit.

■ DO NOT BLOCK VENTS

Do NOT use the player on top of a long-fibered carpet, bed or sofa, and do not cover it with a cloth etc.. This will prevent heat radiation and could result in damage.

■ AVOID HEAT

Do NOT place the unit on equipment generating heat, such as an amplifier.

When installing the unit in a rack, place it on the lowest shelf possible (however, not where it is exposed to dust) and separated from the amplifier to avoid the heat generated by the amplifier or other audio equipment.

■ CAUTION: WHEN PLACING THE UNIT IN A STEREO RACK WITH GLASS DOORS

Be sure there is ample space between the unit and the glass doors when opening the disc table using the remote control. If the disc table opens against strong resistance, **such as a closed glass door**, damage to the unit may result.

■ CONDENSATION

Moisture will form in the operating section of the player if the player is brought from cool surroundings into a warm room or if the temperature of the room rises suddenly. When this happens, player's performance will be impaired.

To prevent this, let the player stand in its new surroundings for about an hour before switching it on, or make sure that the room temperature rises gradually.

Condensation may also form during the summer if the player is exposed to the breeze from an air conditioner. In such cases, change the location of the player.

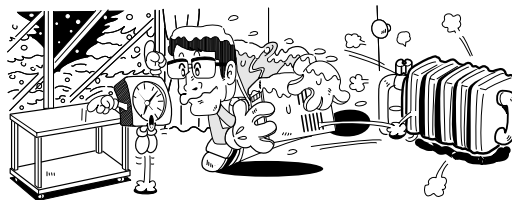

■ SWITCH POWER OFF WHEN NOT USING THE UNIT

Depending on the strength of the TV or radio broadcast signal, having the TV or radio ON while power to the unit is ON may result in stripes on the TV screen or noise. However, this is not a malfunction of this unit or the TV or radio. In such a case, switch power to the unit OFF.

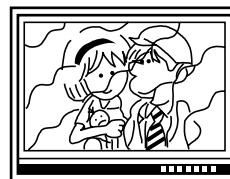

When the DVD player's audio output is connected to a TV, VCR, or other component's audio input, excessively high signal input from a MIC when enjoying karaoke may result in distortion and other adverse effects. If this happens, turn MIC volume down, or switch the Attenuator switch on the rear of the player ON. (See P.62)

CARE OF DISCS

How to hold discs

When loading or removing discs, try not to touch their playing surfaces.



Cleaning

Fingerprints or other dirt on the disc may affect sound and picture quality.

To clean your discs, use a soft clean cloth to wipe them. If necessary, moisten a soft cloth with diluted neutral detergent to remove heavy dirt or fingerprints.

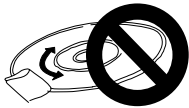

Do not wipe in a circular direction
(Concentric scratches in the disc groove tend to cause noise.)

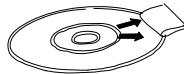

Gently wipe from the inside toward the outer edge.

Discs must not be cleaned with record cleaning sprays, or static prevention sprays, etc. Also do not use volatile liquids such as benzene, or thinner, etc.

NEVER PLAY CRACKED OR WARPED DISCS.

- The disc revolves in the player at high speed when it is played. Never play a cracked, scratched or warped disc. This may damage the player or cause it to malfunction.

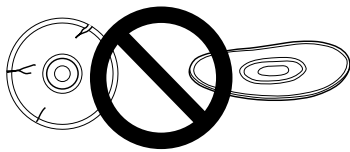

After using discs, store them upright

After playing a disc, always remove it from the player and return it to its jacket. Then store it standing upright away from heat and humidity.

- Store discs carefully. If you store discs at an angle, or stacked on top of each other, discs may become warped even when in their jackets.
- Do not leave discs in locations such as the seat of a car, which may become excessively hot.

CAUTION WHEN USING THE DISC

All rights reserved.

Unauthorized public performance, broadcasting or copying is a violation of applicable laws.

CLEANING CARE

Use a soft, dry cloth for cleaning. For stubborn dirt, soak the cloth in a weak detergent solution; wring well first and wipe. Use a dry cloth to wipe it dry. Do not use any volatile agents such as benzene or paint thinner, as they may damage the surface of the player.

Lens cleaner

The player's pickup lens should not become dirty in normal use, but if for some reason it should malfunction due to soiling, contact your nearest PIONEER authorized service center. Lens cleaners are commercially available, but special care should be exercised in their use since some may cause damage to the lens.

Notes on using the optional optical cable

- Do not route cords around sharp angles. When storing, wind the cords so that they have a diameter of at least 15 cm (6 in.).
- When connecting, push all the way into the terminal.
- Do not use cords with a length of over 3m (10 ft.).
- If moisture or dust has collected on the plug, wipe it with a soft cloth before connecting.

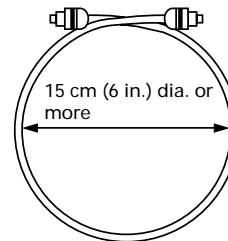

CAUTION RE: USE OF SHAPED CD's

This product is designed for use with conventional, fully circular CD's only.

Use of shaped CD's is not recommended for this product. Pioneer disclaims all liability arising in connection with the use of shaped CD's.

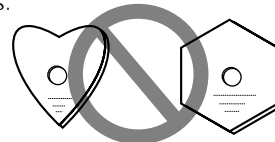

POWER-CORD CAUTION

Handle the power cord by the plug. Do not pull out the plug by tugging the cord and never touch the power cord when your hands are wet as this could cause a short circuit or electric shock. Do not place the unit, a piece of furniture, etc., on the power cord, or pinch the cord. Never make a knot in the cord or tie it with other cords. The power cords should be routed in such a way that they are not likely to be stepped on. A damaged power cord can cause a fire or give you an electrical shock. Check the power cord once in a while. When you find it damaged, ask your nearest PIONEER authorized service center or your dealer for a replacement.

Terms

Dolby digital (AC-3)*

Dolby Digital(AC-3) delivers up to 5.1 channels of discrete multi-channel audio. This is the same system that is used for surround sound in Dolby Digital equipped movie theaters.



For DVD discs, the digital output PCM/□□ jack (coaxial or optical) must be connected to the amplifier or processor's digital input AC-3/PCM jack.

PCM

PCM stands for Pulse Code Modulation and is digital audio. The digital audio of CD or DVD discs is PCM.

DTS

DTS stands for Digital Theater System. DTS is a surround system different to the Dolby Digital (AC-3) system. In order to enjoy the benefits of DTS discs, the digital output jack (either coaxial or optical) of this player needs to be connected to the DTS input jack of an amplifier or processor.

MPEG

Short for Moving Picture Experts Group. This is an international standard for compression of moving images. On some DVDs digital audio has been compressed and recorded in this format.

Title number

Title numbers refer to titles of movies etc. As DVD discs have a large capacity, many movies can be recorded on one disc. For example, when 3 different movies are recorded on a disc, they are divided into TITLE 1, TITLE 2 and TITLE 3. Playback can be operated by selecting the title number.

Chapter number

Chapter numbers are the numbers assigned to sections on a title of the disc, similar to chapters in a book. If the disc includes these numbers, you can locate the section you want very quickly using chapter search and other functions.

Time number

The time number is the playback lapse time of a title in the disc from its beginning. The scene you want to locate can be searched for with the time number using the time number function etc..

TOC

TOC (Table Of Contents) information is data other than audio signal data, recorded at the beginning of a disc. As the name implies, it's like the list of contents in a book, with information such as the number of songs and playback time.

Video CDs

These discs provide MD quality sound, and VHS quality video images. Thanks to MPEG1, the digital signal compression system, a single disc provides up to 74 minutes of continuous digital audio and video. There are also Video CDs with Playback Control (PBC) that let you select playback of desired scenes using menus, and view still images.

Playback Control (PBC)

This refers to signals recorded on a Video CD (Version 2.0) enabling playback control. You can use menus recorded on discs with PBC for easy, interactive search for desired scenes, and playback. You can also enjoy viewing high-resolution/standard resolution still images.

High-resolution images

If the high-resolution still images are recorded on the Video CD, you can enjoy viewing them with four times the resolution of moving images.

Multi-angle

When you watch regular TV programs you are watching the image filmed through the TV camera. Because of this the picture is displayed on your TV from the view point of the TV camera's position. In a TV studio the image is filmed by many cameras at the same time, and one of those images is selected by the program director and transmitted to your TV. If all the filmed images were transmitted to your TV you would be able to select the camera image you want. Some DVD discs are recorded with the angles of all camera's used for filming and these can be selected using this player. These types of discs are called multi-angle discs.

Aspect

Aspect ratio refers to the length to height ratio of TV screens. The ratio of a normal TV is 4:3, while the ratio of a Hi-vision TV or wide TV is 16:9. This allows you to enjoy a picture with a wider perspective.

Parental level

This function was suggested by parents. Parental level restrictions are restrictions incorporated into scenes that parents do not wish their children to view.

Condition memory

"Condition" refers to the various mode settings etc. On this player, various conditions, such as those set during playback etc. can be memorized. This function allows you to play back the same disc at any time without having to reset the condition settings.

* Manufactured under license from Dolby Laboratories, "Dolby", and the double-D symbol are trademarks of Dolby Laboratories. Confidential Unpublished Works, © 1992-1997 Dolby Laboratories, Inc. All right reserved.

Terms

Subtitle

Subtitles are language titles superimposed on movies etc. Up to 32 different subtitle languages can be recorded on a DVD disc. The subtitle function can be used to select the language of your choice.

Regional restriction codes (region number)

Regional restriction codes are built-in to DVD players and DVD discs for each sales region. If the regional code of the DVD player does not match one of the regional codes of the DVD disc, playback will not be possible.

- This unit's region No. is displayed on the rear panel.

Optical digital output

Normally, audio is converted to an electric signal and transmitted through an electric wire from the player to the amplifier etc.. Changing this signal to a digital signal and transmitting it through an optical fiber cable is called optical digital output. (Optical digital input is the side receiving the signal such as the amplifier etc..)

Dynamic range

Dynamic range refers to the difference between the maximum conversion level for transmission/conversion of distortion free signals and noise and/or the minimum level limited by the equipment's characteristics. Decibel units (dB) are used.

Specifications

General

System	DVD system, Video CD system and Compact Disc digital audio system
Power requirements:	AC 120 V, 60 Hz
Power consumption	17 W
Weight	3.0kg (6 lb 10 oz)
Dimensions	420 (W) x 285 (D) x 104 (H) mm (16 ⁹ / ₁₆ x 11 ⁴ / ₁₆ x 4 in.) (Not including protruding cables, etc.)
Operating temperature	+5°C to +35°C (+41°F to +95°F)
Operating humidity	5% to 85% (no condensation)

S-Video Output

Y (luminance) - Output level	1 Vp-p (75Ω)
C (color) - Output level	286 mVp-p (75Ω)
Jacks	S-VIDEO jack

Video Output

Output level	1 Vp-p (75Ω)
Jacks	RCA

Audio Output

Output level	200 mVrms (1 kHz, -20 dB)
Number of channels	2
Jacks	RCA

Digital audio characteristics

Frequency response	4 Hz to 22 kHz (DVD fs: 48 kHz) 4 Hz to 20 kHz (CD)
S/N ratio	115 dB
Dynamic range	90 dB
Wow and flutter	Limit of measurement (±0.001% W. PEAK) or lower

Other Terminals

Optical digital output	Optical digital jack
Coaxial digital output	RCA jack
CONTROL IN	Minijack (3.5Ø)

Accessories

Microphone	1
Remote control unit	1
AA (R6P) dry cell batteries	2
Audio cord	1
Video cord	1
Power cord	1
Operating Instructions	1
Warranty card	1

NOTE:

The specifications and design of this product are subject to change without notice, due to improvement.

Basic
Operation

Detailed
Operation

Karaoke
Operation

Setting

Set-Up

Other
Information



Dear Customer:

Selecting fine audio equipment such as the unit you've just purchased is only the start of your musical enjoyment. Now it's time to consider how you can maximize the fun and excitement your equipment offers. This manufacturer and the Electronic Industries Association's Consumer Electronics Group want you to get the most out of your equipment by playing it at a safe level. One that lets the sound come through loud and clear without annoying blaring or distortion-and, most importantly, without affecting your sensitive hearing.

Sound can be deceiving. Over time your hearing "comfort level" adapts to higher volumes of sound. So what sounds "normal" can actually be loud and harmful to your hearing. Guard against this by setting your equipment at a safe level BEFORE your hearing adapts.

To establish a safe level:

- Start your volume control at a low setting.
- Slowly increase the sound until you can hear it comfortably and clearly, and without distortion.

Once you have established a comfortable sound level:

- Set the dial and leave it there.

Taking a minute to do this now will help to prevent hearing damage or loss in the future. After all, we want you listening for a lifetime.

We Want You Listening For A Lifetime

Used wisely, your new sound equipment will provide a lifetime of fun and enjoyment. Since hearing damage from loud noise is often undetectable until it is too late, this manufacturer and the Electronic Industries Association's Consumer Electronics Group recommend you avoid prolonged exposure to excessive noise. This list of sound levels is included for your protection.

Decibel

Level	Example
30	Quiet library, soft whispers
40	Living room, refrigerator, bedroom away from traffic
50	Light traffic, normal conversation, quiet office
60	Air conditioner at 20 feet, sewing machine
70	Vacuum cleaner, hair dryer, noisy restaurant
80	Average city traffic, garbage disposals, alarm clock at two feet.

THE FOLLOWING NOISES CAN BE DANGEROUS UNDER CONSTANT EXPOSURE

90	Subway, motorcycle, truck traffic, lawn mower
100	Garbage truck, chain saw, pneumatic drill
120	Rock band concert in front of speakers, thunderclap
140	Gunshot blast, jet plane
180	Rocket launching pad

Information courtesy of the Deafness Research Foundation.



Basic
Operation

Detailed
Operation

Karaoke
Operation

Setting

Set - Up

Other
Information

Should this product require service in the U.S.A. and you wish to locate the nearest Pioneer Authorized Independent Service Company, or if you wish to purchase replacement parts, operating instructions, service manuals or accessories, please call the number shown below.

800 – 872 – 4159

Please do not ship your product to Pioneer without first calling the Customer Service Department at the above listed number for assistance.

PIONEER ELECTRONICS SERVICE, INC.
CUSTOMER SUPPORT DIVISION
P.O. BOX 1760, LONG BEACH,
CA 90801-1760, U.S.A.

For warranty information please see the Limited Warranty sheet included with your product.

Published by Pioneer Electronic Corporation.
Copyright © 1998 Pioneer Electronic Corporation.
All rights reserved.

PIONEER ELECTRONIC CORPORATION

4-1, Meguro 1-Chome, Meguro-ku, Tokyo 153-8654, Japan

PIONEER NEW MEDIA TECHNOLOGIES, INC.

Headquarters:

2265 East 220th Street, Long Beach, California 90810, U.S.A. TEL: (310) 952-2111